

TDC8001

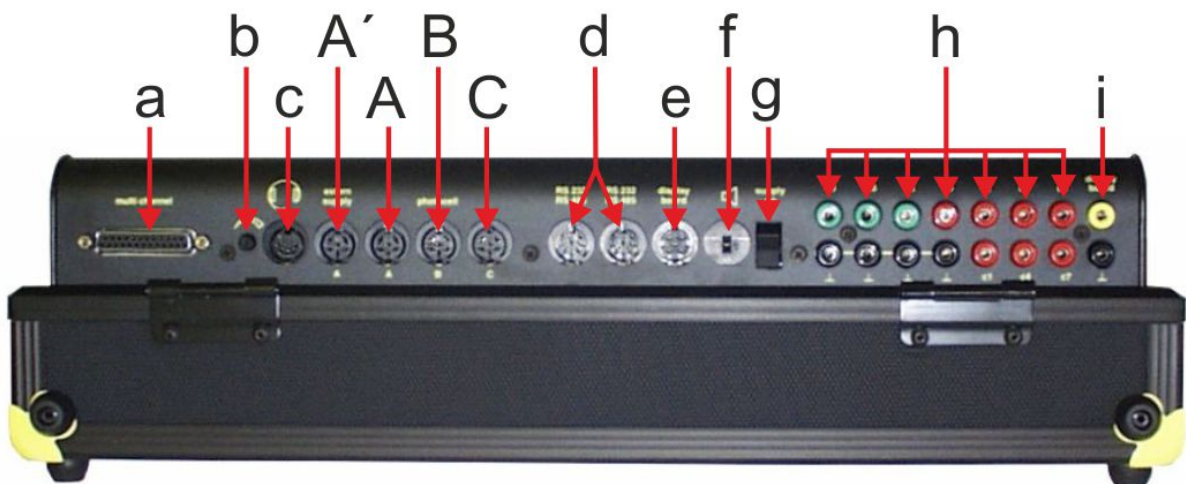







ALGE-TIMING



Manual



Operating Elements and Connections

- 1 Start display
 - 2 Charging control (LED)
 - 3 Meter for monitoring power supply and alignment of photocell
 - 4 Paper roller
 - 5 Running time display
 - 6 Finish display (for some programs here also the time is indicated)
 - 7 Info display
 - 8 Finish keypad:
 - STOP..... manual stop impulse
 - CLEAR ... clear stop impulse
 - BLOCK... stop impulse invalid (as long as the key is pressed)
 - INPUT edit stop times
 - ENTER ... confirm input (counting up start numbers)
 - 0-9 numeric keys for input of start number of runner in finish
 - 9 Function keypad:
 - YES for confirmation
 - NO for denial (continuation)
 - PRINT switch printer off or on
 - PRINT buffer mode on or off
 -  + PRINT printer on/off
 - TEST info display (7) shows device test
 -  next in menu
 -  previous in menu
 -  special functions
 - CLASS ... ranking
 - MEMO finish memory
 - MENU..... always in combination with further key, menus of the key functions are selected
 -  always in combination with a further key
-
-  function key 1
 -  function key 2
 -  function key 3
 -  function key 4
-
- 10 Paper feed
 - 11 Paper compartment and thermal printer
 - 12 Start keypad:
 - STARTmanual start impulse
 - CLEAR....clear start impulse
 - BLOCK ...start impulse invalid (as long as the key is pressed)
 - INPUTedit start times
 - ENTER ...confirm input (counting up start numbers)
 - 0-9.....numeric keys for input of start number of runner at start
-
- a Connection for Extender and Multichannel (channel 0-9)
 - b Volume control for headset
 - c Connection for headset
 - A' Jack for connecting the charging device PS12, otherwise identical to jack A
 - A Jack for connecting the finish photocell (also PS12, identical to jack A')
 - B Jack for connecting the finish photocell at parallel slalom
 - C Jack for connecting an intermediate time photocell or the charging device PS12
 - d Two identical jacks with RS232 and RS485 interface
 - e Jack for connecting an **ALGE** scoreboard
 - f Jack for connecting a loud speaker (e. g. for show jumping)
 - g ON / OFF switch
 - h Banana jacks for all 10 channels:
 - c0..... start channel
 - c1..... stop channel
 - c2..... intermediate time 1
 - c3..... intermediate time 2 (start channel 2 Dual-Timer)
 - c4..... intermediate time 3 (finish channel 2 – Timer)
 - c5..... intermediate time 4
 - c6..... intermediate time 5
 - c7..... intermediate time 6
 - c8..... intermediate time 7
 - c9..... intermediate time 8
 - i „display board“ output (channel 2) on banana jacks



Declaration of Conformity

We declare that the following products comply with the requirements of the listed standards.

We, **ALGE-TIMING GmbH**
Rotkreuzstrasse 39
A-6890 Lustenau

declare under our sole responsibility, that the timing device

Time Data Computer TdC8001

is in conformity with the following standard(s) or other normative documents(s):

Safety: EN 60950-1:2006 + A11:2009
EMC: EN55022:2006+A1:2007
EN55024:1998+A1:2001+A2:2003
EN61000 3-2:2006 + A1:2009 + A2:2009
EN61000 3-3:2008

Additional Information:

The product herewith complies with the requirements of the Low Voltage Directive 73/23/EEC, also the EMC Directive 2004/108/EG and accordingly carries the CE-marking.

Lustenau, 10.03.2010

ALGE-TIMING GmbH

A handwritten signature in blue ink that reads "Albert Vetter". The signature is written in a cursive style and is positioned above a horizontal line.

Albert Vetter
(General Manager)

Important Information

General

Before using your **ALGE-TIMING** device read the complete manual carefully. It is part of the device and contains important information about installation, safety and its intended use. This manual cannot cover all conceivable applications. For further information or in case of problems that are mentioned not at all or not sufficiently detailed, please contact your **ALGE-TIMING** representative. You can find contact details on our homepage www.alge-timing.com

Safety

Apart from the information of this manual all general safety and accident prevention regulations of the legislator must be taken into account.

The device must only be used by trained persons. The setting-up and installation must only be executed according to the manufacturer's data.

Intended Use

The device must only be used for its intended applications. Technical modifications and any misuse are prohibited because of the risks involved! **ALGE-TIMING** is not liable for damages that are caused by improper use or incorrect operation.

Power supply

The stated voltage on the type plate must correspond to voltage of the power source. Check all connections and plugs before usage. Damaged connection wires must be replaced immediately by an authorized electrician. The device must only be connected to an electric supply that has been installed by an electrician according to IEC 60364-1. Never touch the mains plug with wet hands! Never touch live parts!

Cleaning

Please clean the outside of the device only with a smooth cloth. Detergents can cause damage. Never submerge in water, never open or clean with wet cloth. The cleaning must not be carried out by hose or high-pressure (risk of short circuits or other damage).

Liability Limitations

All technical information, data and information for installation and operation correspond to the latest status at time of printing and are made in all conscience considering our past experience and knowledge. Information, pictures and description do not entitle to base any claims. The manufacturer is not liable for damage due to failure to observe the manual, improper use, incorrect repairs, technical modifications, use of unauthorized spare parts. Translations are made in all conscience. We assume no liability for translation mistakes, even if the translation is carried out by us or on our behalf.

Disposal

If a label is placed on the device showing a crossed out dustbin on wheels (see drawing), the European directive 2002/96/EG applies for this device.

Please get informed about the applicable regulations for separate collection of electrical and electronical waste in your country and do not dispose of the old devices as household waste. Correct disposal of old equipment protects the environment and humans against negative consequences!



Copyright by **ALGE-TIMING GmbH**

All rights reserved. Any duplication, either in full or in part, requires the prior written consent of the copyright holder.

Table of Contents

1	Device Description	8
1.1	Standard Programs	8
2	Getting Started	10
2.1	Power Supply	10
2.1.1	Charging Device PS12	10
2.1.2	External Battery (12 V Car Battery)	10
2.1.3	Operating Time	10
2.1.4	Charge Condition of the Battery	10
2.2	Printer	11
2.3	Connection of Auxiliary Devices	12
2.4	Select Language	15
2.5	Memory	15
2.5.1	Memory Organization	15
2.5.2	Clear Memory	15
2.6	Select a Race	16
2.7	Precision	16
2.8	Set Timing Modes	16
2.9	Enter Groups	17
2.10	Test Function – Checking the TdC 8001	17
2.11	Synchronized Start	18
3	Timing	19
3.1	Turn on TdC 8001	19
3.1.1	First Heat	19
3.1.2	Turning on and continuation in the same heat	21
3.1.3	Second (next) heat	21
3.2	Keypad Functions	23
3.2.1	Start Keypad (12)	23
3.2.2	Finish Keypad (8)	23
3.2.3	Function Keypad (9)	24
3.3	Start Mode	25
3.3.1	Single Start	25
3.3.2	Start Procedure for 2 nd Heat	26
3.3.3	Group Start	26
3.3.4	Mass Start	26
4	Special Functions.....	27
4.1	Test – Check TdC 8001	27
4.2	Block – Deactivate Impulse Channels	27
4.2.1	Block Start	27
4.2.2	Block Finish	27
4.2.3	Individual Setting of Channels	27
4.3	Edit Times	28
4.3.1	Edit Start Times	28
4.3.2	Edit Finish Times	30
4.4	Memo – Buffer for Mass Finish	33
4.5	Class – Print Ranking.....	35
4.5.1	Ranking in 1 st Heat	35
4.5.2	Ranking in 2 nd heat	38
4.5.3	Race Points	39
4.6	Print – Turn Printer On or Off	39

5	Main Menu – General Settings.....	40
5.1	Restoring the Default Settings.....	40
5.2	Open Main Menu	40
5.3	Main Menu – Brief Description	40
6	Programs	52
6.1	Split, Program 1	53
6.2	Split-Sequential, Program 3	56
6.3	Parallel Slalom	59
6.3.1	Parallel Diff. (parallel slalom with finish difference time), program 4.....	59
6.3.2	Parallel Slalom Net, Program 5	63
6.4	Dual Timer, Program 6	69
6.5	Speed, Program 7.....	73
6.6	Speed Skiing, Program 8	76
6.7	Carving, Program 9.....	79
6.8	10-Channel Timer, Program 10	82
6.8.1	10-Channel Timer 1, Program 101	82
6.8.2	10-Channel Timer 2, Program 102	85
6.9	Equestrian Sport, Program 11	88
6.10	Speed Skating, Program 12	89
6.11	Cycling, Program 13.....	93
6.11.1	Road Races, Program 131	93
6.12	Dog Sports, Program 14	96
6.12.1	Challenge, Program 141.....	96
6.13	TdC Test, Program 15.....	96
7	Description of Accessory Devices	98
7.1	Multichannel MC18	98
8	Technical Data	99
8.1	Connection System.....	100
8.1.1	Photocell Jacks and External Supply.....	100
8.1.2	Connection for Headset (c).....	100
8.1.3	Speaker Jack (f)	100
8.1.4	Display Board Jack (e).....	100
8.1.5	RS232 / RS485 (d)	101
8.1.6	Display Board (i)	101
8.1.7	Banana Jacks Channel 0 to 9 (h)	101
8.1.8	Multichannel (a).....	101
8.2	RS232 Interface (a, d).....	101
8.2.1	Inquiry of Device Settings via RS232 Interface.....	103
8.2.2	Settings of Main Menu via RS232 Interface.....	103
8.2.3	Retrieve Data via RS232 Interface	105
8.3	RS485 Interface (a,d).....	107
8.4	Display Board (e) – Interface for Display Board.....	108

1 Device Description

With the ALGE Timedata Computer TdC 8001 you have acquired an ideal and absolutely future-proof timing computer. In case you have any questions regarding operating, please contact your local ALGE agent. Good luck with your ALGE Timedata Computer TdC 8001.

1.1 Standard Programs

SPLIT:

Program 1

Program for timing with intermediate time. Precision is adjustable. 256 heats are possible. There is one start channel (c0), one stop channel (c1) and up to 8 intermediate time channels (c2 – c9).

SPLIT SEQUENTIAL (SPLIT SEQU.):

Program 3

Program for timing lap times and run times, precision adjustable. Before the race the number of laps must be entered. 256 heats are possible. There is a start channel (c0), a stop channel (c1) and up to 8 intermediate time channels (c2 – c9).

PARALLEL SLALOM:

Program 4 Parallel Diff. (Parallel slalom with difference time):

The difference time between two racers is shown together with the winning course (blue or red).

Program 5 Parallel Net (Parallel slalom with net time and difference time):

The net time of each racer and the difference time are measured. From both heats the total time and total difference time is calculated.

DUAL TIMER:

Program 6

Net timing with intermediate times on both courses with one racer each on the course. The start can be executed individually or together for both courses. The evaluation can be carried out individually or together for both courses.

SPEED (Speed measurement):

Program 7

Program for measuring speed, selectable in km/h, m/s or mph. The measuring distance has to be in between 1 and 9999 meters.

SPEED SKIING (Speed measurement for skiing):

Program 8

Program for measuring of time and speed for Speed Skiing.

Program	Prg. No.	Page
Split	1	53
Split Sequential	3	56
Parallel Diff.	4	59
Parallel Net	5	63
Dual Timer	6	69
Speed	7	73
Speed Skiing	8	76
Carving	9	79
10-channel-Timer	10	82
10-channel-Timer 1	101	82
10-channel-Timer 2	102	85
Equestrian Sports	11	88
Standard Jumping A1	111	
Standard Jumping A2	112	
Standard Jumping AM3	113	
Standard Jumping AM4	114	
Standard Jumping AM5	115	
Standard Jumping AM6	116	
Standard Jumping AM7	117	
Standard Jumping AM8	118	
Time Jumping C	120	
Two Stage Jumping	121	
American Stage F	122	
American Stage / Time	123	
Standard / Time	124	
Speed Skating	12	89
Cycling	13	92
Cycling Road	131	92
Dog Sports	14	95
Challenge	141	95
TdC Test	15	95

CARVING:**Program 9**

Countdown of preset time until 0 and then upward running clock.

10-CHANNEL TIMER:**Program 10****Program 101 10-channel Timer 1:**

Program with split timing for 10 channels. Each start number can have any number of stop impulses on the same channel. Output of times on same scoreboard.

Program 102 10-channel Timer 2:

Program with split timing for 10 channels. Each start number can have any number of stop impulses on same channel. Output of times on separate channels on separate scoreboards.

EQUESTRIAN SPORTS:**Program 11**

Programs for show jumping events. Please ask your ALGE agent for a separate manual.

SPEED SKATING:**Program 12**

Program for timing speed skating

CYCLING:**Program 13****Program 131 Cycling-Road**

For road races to control the scoreboard (run time, time difference, average speed).

DOG SPORTS:**Program 14****Program 141 Challenge:**

Program for Agility „Challenge“. Please ask your ALGE agent for a separate manual.

TDC-TEST:**Program 15**

Program for testing the TdC 8001

2 Getting Started

2.1 Power Supply

The TdC8001 has an integrated battery pack. The battery pack consists of six welded NiMH cells. It can be charged with an **ALGE** charging device PS12 or a 12 volt car battery. The charging voltage must be in between 11 and 16 Volt with the device switched on.

2.1.1 Charging Device PS12

The TdC 8001 can be charged directly from the mains (100-240VAC/50-60Hz) with the charging device.

- Connect PS12 to mains
- Connect PS12 at the jack „extern supply“ (A') or „photocell“ (A, B or C)
- Turn on TdC 8001 (ON / OFF switch g)
- Red LED (2) must glow
- The TdC 8001 must be turned on during charging so that the internal charging electronic works.
- The TdC 8001 can be charged during normal timing operation.
- Charging time with PS12 is approx. 12 hours
- Open circuit voltage of PS12 is 15 volt
- Charging voltage of PS12 is 11.7 volt

Important: The batteries are not charged when TdC 8001 is turned off!

2.1.2 External Battery (12 V Car Battery)

Every battery with a voltage of 12 volt and a power of at least 5 Ah can be used for charging and supplying the TdC 8001.

- Connect cable 005-02 to jack „extern supply“ (A')
- Connect automotive clip (+) at positive pole of the battery
- Connect automotive clip (-) at negative pole of the battery
- red LED (2) at TdC 8001 must glow

2.1.3 Operating Time

The battery status is continuously indicated with the meter (3). As long as the indicator of the meter is in the green area, the TdC 8001 can be operated.

2.1.4 Charge Condition of the Battery

The TdC 8001 has six NiMh batteries with 1.2 volts and 4.5 Ah each. The voltage of the batteries can be shown in the info display (7) at any time by pressing the key <TEST>.

The voltage of the batteries is automatically checked and so a warning is shown in the info display (7) in case the batteries become empty.

Pre Warning: The display shows “nearly empty batteries”. The voltage is 6.8 volts.

You can continue to work until a voltage of 5.8 volts. If possible, the charging device PS12 or an external 12 volts battery should be connected.

Shutdown: The display shows “empty batteries”. The voltage is 5.8 volts.

If a voltage of 5.8 volts is reached, the TdC 8001 automatically shuts down into stand-by. This is necessary for keeping the memory. Work can only be continued if the battery is charged with a charging device or an external battery. The TdC 8001 does not have to be re-synchronized.

2.2 Printer

The TdC 8001 has an integrated thermal printer. The original **ALGE** paper is best suited for this printer. You can recognize the paper by the **ALGE** logo on its back. It is available with your **ALGE** agent. The printer is very user friendly. The print head does not move and the roll is integrated in the paper cover. Replacing the paper is therefore very easy.

The printer works very fast and silent. With external power supply up to 6 lines are printed per second, with battery operation 4 lines per second. It is automatically activated when turning the TdC 8001 on. As soon as a program of the TdC 8001 is activated, you can set the following with the key <PRINT>:

Print Mode: All printer data is printed. After turning the TdC8001 on, the print mode is activated automatically.

Buffer Mode: All printer data is stored but not printed. This mode should be activated during paper replacement

- Printer in print mode, press <PRINT>
- Printer in buffer mode; <PRINT>
- Printer switches to print mode and prints all stored data

Turn Printer Off: Printer is turned off and sent data is lost.

- Printer in print mode; press <ALT> and <PRINT> at the same time
- Printer is off; press <PRINT> or <ALT> and <PRINT> at the same time
- Printer in print mode

Replace Paper: - Open paper compartment

- Replace empty roll by new one
- Thread through yellow cover at tearing edge
- Close printer cover
- Note: Make sure that the paper protrudes through the edge when placing the cover on the device.
- A red stripe on the thermal paper indicates a soon end of the paper.

During the print out you must not tear at the paper strip as otherwise the paper will jam. If the paper is jammed, press black lever forward (direction of the arrow) and at the same time carefully tear the paper out. Keep the paper dry.

2.3 Connection of Auxiliary Devices

- Charging unit PS12



- External 12 V battery

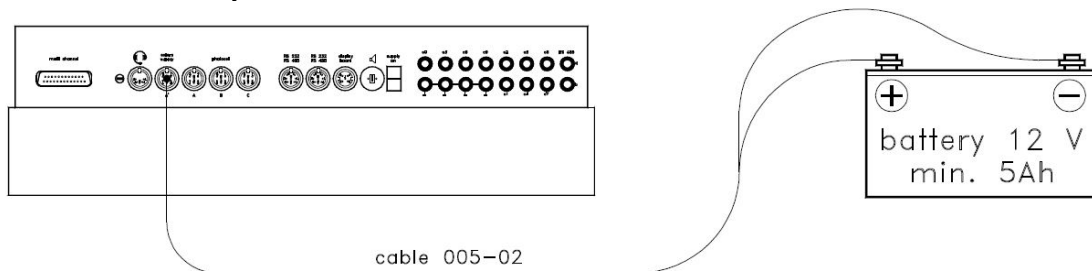

- Start gate STSn with headset

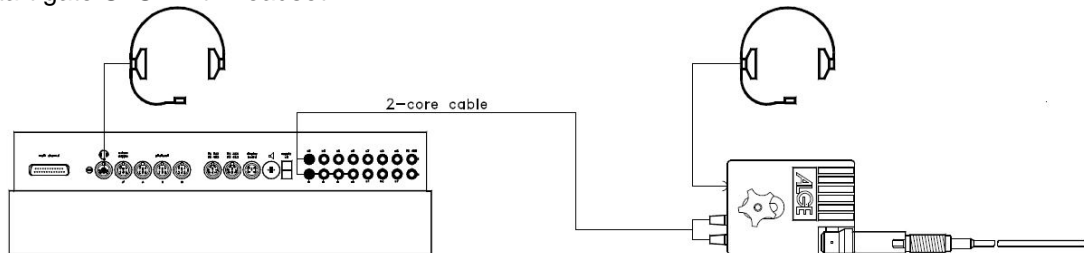

- Photocell PR1a

- o Finish photocell:
When operating with one finish, the photocell should be connected to jack (A'). For a race with several courses, the photocell of course 1 is connected to jack (A'), of course 2 to jack (A) and of course 3 to jack (B) (cable 001-xx).
- o Intermediate time (supply from timing device):
The cable depends on used program. For Split the connections can be as described above but cable 003 has to be used (up to 100 m this cabling is possible).
- o Intermediate time (two-core cable):
Any channel can be connected via the banana jack. For this cabling the photocell has to be supplied internally (battery in photocell).
The two-core cable is connected to the TdC 8001 and to the photocell, e.g. cable reel KT500 or KT300.

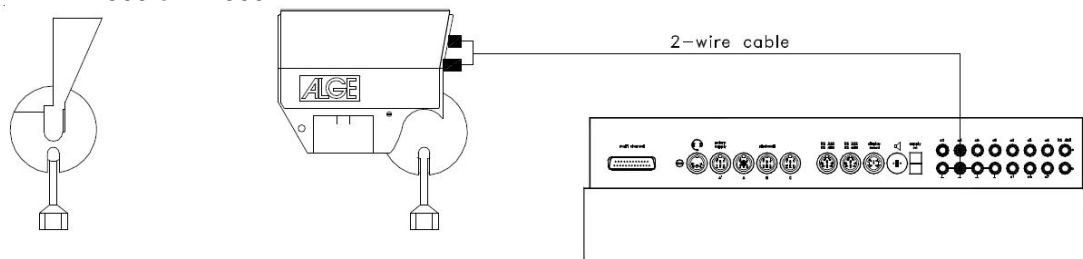

- Display Board GAZ:
For distances of more than 10 meters, any two-core cable with banana plugs can be used.

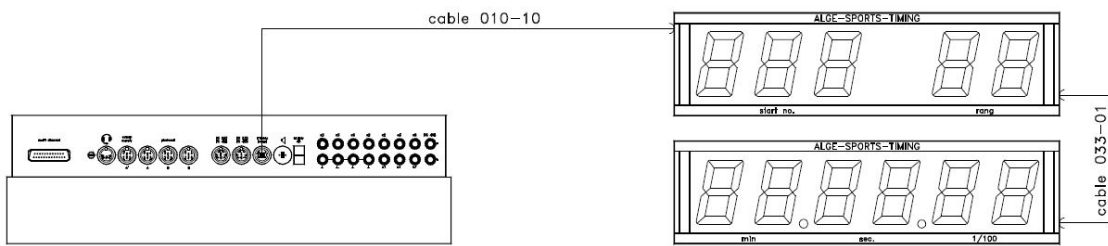

- Start microphone SM8 with speech amplifier SV4/SM:

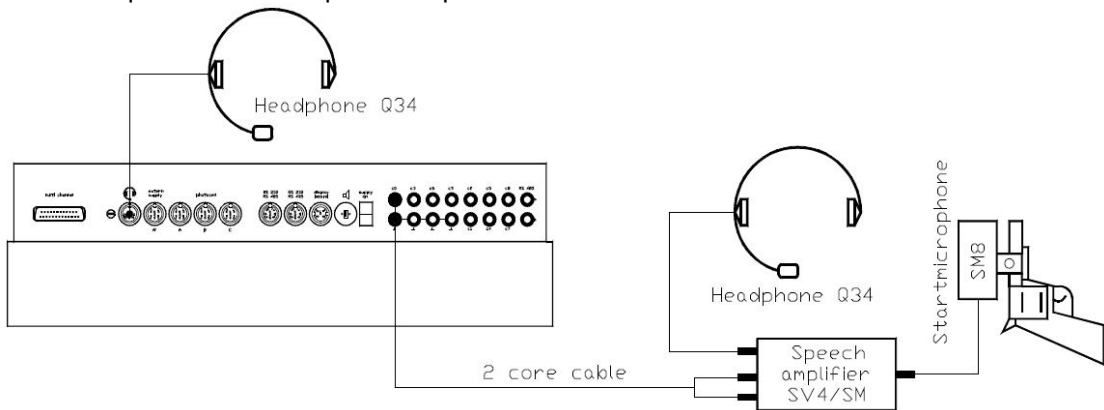

- Photocell adapter LA5:

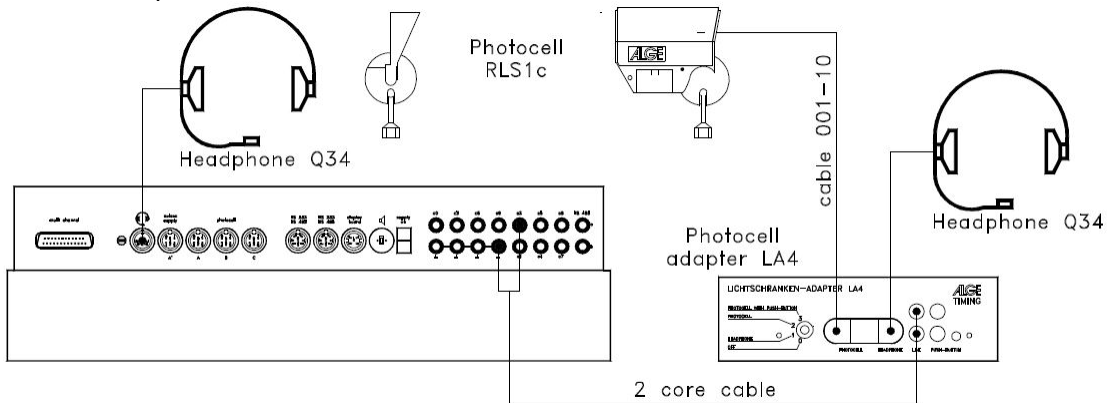

- Push-button:

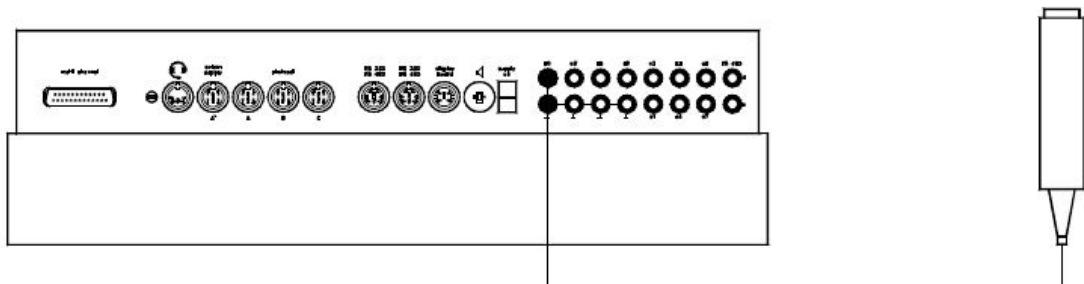

- Speaker:

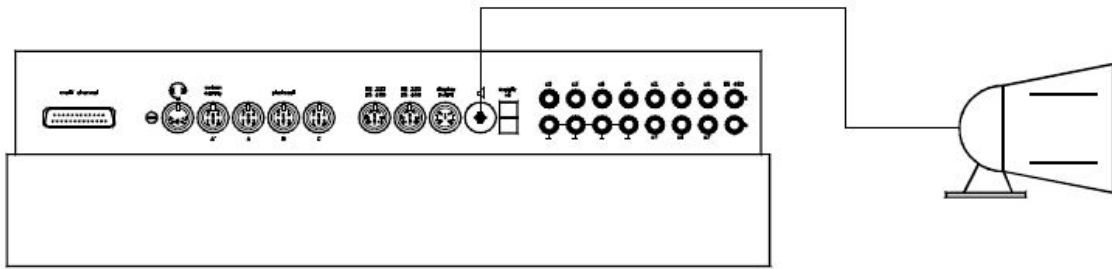

- PC:

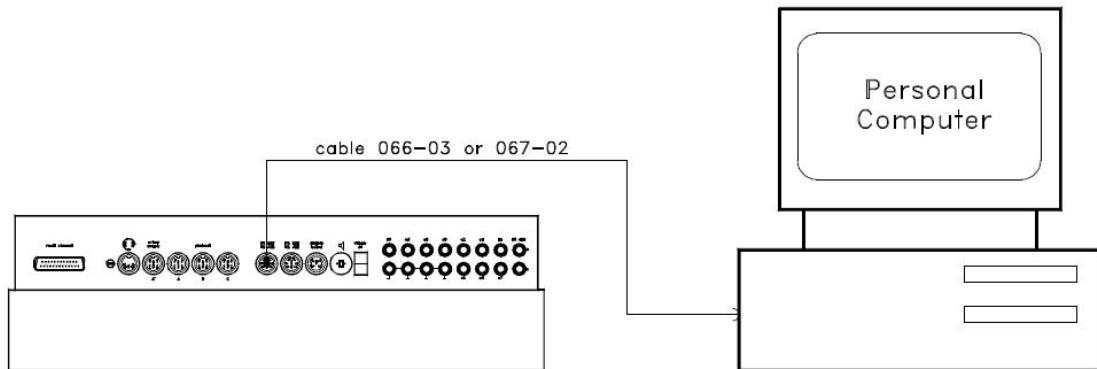

2.4 Select Language

The following languages are available:

German: <1>	Italian: <4>
English: <2>	Spanish: <5>
French: <3>	Finnish: <6>

- Keep the corresponding figure (see above) on the finish keypad pressed when turning on
- Turn on TdC 8001
- Let go of the key when program can be selected
- Language will be stored even after turning off.

2.5 Memory

The TdC8001 can store about 18,000 times in a maximum of four separate races. In one race a maximum of 9,999 times can be stored. Races 1 and 2 have a total of 9,999 disk space. If race 1 has already saved 1,000 times, race 2 can dispose of another 8,999 times. The same applies for races 3 and 4 with a total of 8,067 disk space.

In each race a maximum of 256 heats can be executed. The memory can be deleted after the program selection when turning on the TdC 8001.

Start time (time of day), finish time (time of day) and run time (for difference time mode) are always saved for the current heat. For previous heats, a memory time (total time for all stored heats) is saved.

Times saved in 1. heat:

- Start time (only difference timing)
- Finish time (only difference timing)
- Intermediate time (every one)
- Run time

Times saved in 2. heat:

- Memory time
- Start time (only difference timing)
- Finish time (only difference timing)
- Intermediate time (every one)
- Total time

2.5.1 Memory Organization

For every race a limited memory capacity is available:

Race 1: 9,999 times, if race 2 has not saved any data
 Race 2: 9,999 times, if race 1 has not saved any data
 Race 3: 8,067 times, if race 4 has not saved any data
 Race 4: 8,067 times, if race 3 has not saved any data

2.5.2 Clear Memory

After turning on the TdC 8001 the program is selected. You can now choose if you want to clear the memory. The info display (7) shows the following:

Clear race:	9746/ 253 R1		
	0/ 253 R2		
	51/ 6473 R3		
Continue: ENTER	943/ 6473 R4		

- F1 Pressing the <F> key clears
- F2 race separately
- F3
- F4

If you press an <F> key, the corresponding race is marked with an arrow. You can clear several races at the same time. Clear: Press <ENTER> on finish keypad (8). If for example races 1 and 3 are cleared, the info display shows the following:

Clear race:	9746/ 253 R1 <		
	0/ 253 R2		
	51/ 6473 R3 <		
Continue: ENTER	943/ 6473 R4		

- F1
- F2
- F3
- F4

If you only press <ENTER> without previously having selected a race with the <F> keys, no memory is cleared.

2.6 Select a Race

After clearing the memory, the current race has to be selected. A maximum of four races can be stored at the same time. Every race is completely independent, i.e. every race can use start number from 1 to 9999 and execute up to 256 heats.

Select race:	7012/ 2987 R1 <	F1
	0/ 2987 R2	F2
	651/ 6473 R3	F3
Continue: ENTER	943/ 6473 R4	F4

For every race two figures are entered. The first figure indicates how many disk spaces are occupied, the second one how many disk spaces are free. A deleted race has to show 0 as first figure. The last race is suggested automatically. If you want to use this again, just press <ENTER>. If you want to select another race, use either of the <F> keys. The selected race is indicated by an arrow.

Memory was not cleared:

If a race is selected of which the memory is not cleared, the following is shown at the info display (7):

Select heat:	SAME (1) <	F1	(1) means 1. heat
	NEXT (2)	F2	(2) means 2. heat
Continue: ENTER			

- If the same heat is selected, you can continue in the same heat as before.
- If the next heat is selected, a new heat is started.

New heat:

- All valid run times (and total times) are saved for further heats.
- All other times are cleared.

2.7 Precision

The precision with which run, intermediate and total time are shown, can be selected with the <F> keys. The time of day is always measured with a precision of 1/10,000 seconds.

Select precision:	1 s	F1	Precision: Seconds
	1/10 s	F2	Precision: Tenths of a second
	1/100 s <	F3	Precision: Hundredth of a second
Continue: ENTER	1/1000 s	F4	Precision: Milliseconds

2.8 Set Timing Modes

There are two possibilities of timing: difference and absolute. The timing mode for most of the programs must be set in the prefix.

Select timing:	ABSOLUTE	F1
	DIFFERENCE <	F2
Continue: ENTER		

Absolute:

Time starts from 0:00.00. For every competitor only the run time (total and intermediate) is saved. This mode should mainly be used for mass starts.

Advantage: for every competitor only one disk space is used (1 heat, no intermediate time)

Disadvantage: time corrections are impossible

Difference:

Input the time of day when switching the device on. For every competitor start- finish- and run time is printed. This mode should always be used for single and group starts.

Advantage: time corrections are possible

Disadvantage: for every competitor at least 3 disk spaces are occupied (start, finish and run time)

2.9 Enter Groups

The competitors can be divided into a maximum of 99 groups. One group has to consist of consecutive start numbers. If groups are entered, the rank is output within the group. A group evaluation can be created for the ranking; a group start is possible (all group members start at the same time).

Input groups?	YES
	NO <
Continue: ENTER	

F1 If you do not want to enter groups
F2 press <NO> or <F2>; if you want to enter groups press <YES> or <F1> and <ENTER>

GROUPS:	Gr 1:	1	>	<u>0</u>
Save with: ENTER				

Enter the last start number of each group as first start number of the following group the next start number is automatically shown.

GROUPS:	Gr 1:	1	>	60
	Gr 2:	61	>	90
	Gr 3:	91	>	120
Save with: ENTER	Gr 1:	121	>	<u>0</u>

1. Group from StNo. 1 to 60
2. Group from StNo. 61 to 90
3. Group from StNo. 91 to 120
No input yet

Attention: You should always leave some vacant start numbers in a group so that you can use them in case of late entries.

2.10 Test Function – Checking the TdC 8001

The info display (7) shows the following picture as long as <TEST> is pressed:

C0	=	4,9V battery	=	7,3V
C3	=	4,9V photocell	=	4,9V
C6	=	4,9V extender	=	0,00A
#	#	#	#	#
c0	c1	c2	c3	c4
c5	c6	c7	c8	c9

The test function shows the state of the device. All 10 channels are always monitored regarding their state (4. line). If a channel blinks, it short-circuited. For the channels 0, 3 and 6 the voltage is always shown directly. Moreover, the voltages of the battery and the photocells as well as the power consumption of the extender are displayed.

The channels 0, 3 and 6 should have in normal state (open) 5 V. At an impulse the voltage has to break down to 0 V.

The battery has a voltage of about 7.4 V when fully charged. When empty the battery voltage is about 5.8 V. With this voltage, the device cannot operate anymore. A warning about the state of the battery is issued at 6.8 V.

The stabilized voltage "photocell" that supplies the photocell(s) has to be about 5 V.

The power consumption through the RS485 interface (d) must not exceed 1 A. In case of a consumption of more than 1 A the supply for the extender is turned off.

Performance test – Check of the two-core start-finish connection:

Check of a two-core cable at banana jack c0, c3 or c6

- Turn on TdC 8001 (g)
- Select any program
- Go through start menu until the TdC 8001 is ready
- Keep <TEST> pressed
- Info display (7) shows measuring's
- Measuring's of c0, c3 and c6 are important for the performance test

Shor circuit test:

- Cable is open at the other end
- Press <TEST>
- Voltage at the measured channel must be about 4.9 V

Shunt test:

- Short-circuit cable at the other end (connect the banana plugs)
- Press <TEST>
- Voltage at short-circuited channel must be between 0 and 0.9 V. In case the voltage is higher than 0.9 V, the resistance of the cable is too large (maximum 2,000 Ohm loop resistance).

The voltage measurement is just a quick test of the connections before a race. You should use a multimeter to check the resistance of the connection if it has not been used for a long time. Most of the problems with timing are caused by bad connections. The cables should be inspected in good time before the season's opening. Bad cables or plugs cannot be replaced shortly before a race. Your ALGE representation can assist here.

Needle of meter (3) swings:

The needle starts to swing if the photocell is misaligned. The photocell must be checked. The swinging of the needle can also be caused by a long impulse or short-circuit.

2.11 Synchronized Start

Synchronization with other timing devices is possible. The synchronization is carried out during setting of the time of day in the main menu after turning on the TdC 8001. Connect the timing devices via start banana jacks (or cable 004) with each other.

Time: 10:15:23	OK	<	F1	time and date are correct
Date: 11-02-28	WRONG		F2	time or date is wrong
Continue: ENTER				

There are two ways to synchronize:

- Synchronization by internal clock
- Manual synchronization

Synchronization by internal clock:

- Press <F1> and then <ENTER>
- Info display (7) shows:

Time: 10:15:23
Date: 11-02-28

Synchronize: on minute change

Manual synchronization:

- Press <F2>, then
- Press <ENTER>
- Info display (7) shows:

Time: 10:15:23
Date: 11-02-28

Save with: ENTER

- Enter time of day with finish keypad (8) and confirm with <ENTER>
- Enter date with finish keypad (8) and confirm with <ENTER>

Time: 11:25:23
Date: 11-03-17

Synchronize: START key / channel C0

- Press <START> for synchronization or synchronize by external start impulse c0
- TdC 8001 is ready for timing

3 Timing

3.1 Turn on TdC 8001

3.1.1 First Heat

- Turn on TdC 8001 with switch (g) (language settings see chapter 0)
- Info display shows the following:

```

ALGE-TIMING
TdC 8001

DEU V02.B1
```

Company
Device

Language and current version

- After a few seconds the program used last is shown.

```

Program 1: SPLIT

Select: YES/NO or Program number: 0#
```

Program

possible selections

- Select shown program with <YES> or <ENTER>. For selection of another program enter program number or select with <NO> and cursor keys any program.
- Info display (7) shows the currently occupied disk space (see chapter 2.5)

```

Clear race:          1345/ 8654 R1 <  F1
                   0/ 8654 R2      F2
                   1250/ 6283 R3    F3
Continue: ENTER     534/ 6283 R4    F4
```

- Four separate races can be stored (R1, R2, R3 and R4). It is shown how many disk spaces are occupied (first number) and how many are vacant (second number).
- By pressing one of the F-keys 1-4 the races that are to be cleared can be indicated (arrow at the end of the line).
- Clear selected races with <ENTER>.
- Select race:

```

Select race:         0/ 9999 R1 <  F1
                   0/ 9999 R2      F2
                   1250/ 6283 R3    F3
Continue: ENTER     534/ 6283 R4    F4
```

- Select race with one of the F-keys 1-4 and confirm with <ENTER>.
- When the selected race is clear, you must select the precision:

```

Select precision:   1 s      F1  precision: seconds
                   1/10 s   F2  precision: 1/10 seconds
                   1/100 s < F3  precision: 1/100 seconds
Continue: ENTER    1/1000 s  F4  precision: 1/1000 seconds
```

- The precision sets what precision is displayed. It only applies to calculated times (run time, intermediate time, etc.) not for time of days.
- The precision is selected with one of the F-keys 1-4. The last used precision is suggested.
- Confirm precision with <ENTER>.
- After the precision the timing mode has to be selected:

Select timing: Continue: ENTER	ABSOLUTE DIFFERENCE <	F1 Timing without time of days F2 Timing with time of days
---------------------------------------	--------------------------	---

- Select timing mode with <F1> or <F2> (see chapter 2.8)
- After the timing mode, the start mode must be selected:

Select start mode: Continue: ENTER	SINGLE START < GROUP START MASS START	F1 every competitor start individually F2 mass start within a group F3 all competitors start at the same time
---	---	---

- Select start mode with F-keys 1-3 (see chapter 0)
- Confirm start mode with <ENTER>.
- After the start mode the groups have to be defined:

Enter groups? Continue: ENTER	YES NO <	F1 F2
--------------------------------------	-------------	----------

- For entering groups press <YES> or <F1>, for no groups press <NO> or <F2>.
- When groups are entered, the info display (7) shows the following:

GROUPS: Save with: ENTER	<table style="width: 100%; border-collapse: collapse;"> <tr><td style="width: 10%;">Gr 1:</td><td style="width: 10%;">1</td><td style="width: 10%;">></td><td style="width: 10%;">50</td></tr> <tr><td>Gr 2:</td><td>51</td><td>></td><td>100</td></tr> <tr><td>Gr 1:</td><td>101</td><td>></td><td>230</td></tr> <tr><td>Gr 4:</td><td>231</td><td>></td><td>0</td></tr> </table>	Gr 1:	1	>	50	Gr 2:	51	>	100	Gr 1:	101	>	230	Gr 4:	231	>	0	The last start number of each group has to be entered. In case three groups are entered as shown here, for the fourth group press two times <ENTER>
Gr 1:	1	>	50															
Gr 2:	51	>	100															
Gr 1:	101	>	230															
Gr 4:	231	>	0															

- After the groups, the time of day has to be entered:

Time: 10:25:36 Date: 11-02-2 Continue: ENTER	OK < WRONG	F1 internal clock F2 enter time of day confirm with <ENTER>
--	---------------	---

- You can enter the time of day in two ways (see chapter 2.11)
- After setting the time of day the TdC 8001 is ready for the start of the first competitor.
- For every competitor the following times are printed:

0001	SZ	10:07:04.640	start time
	ZZ	10:08:35.150	finish time
	LZ	1:30.500	run time

3.1.2 Turning on and continuation in the same heat

- The activation operation is the same as with the 1. Heat.
- As the race is continued in the same heat, the memory must not be cleared.
- Select correct race.
- The info display (7) shows as follows:

Select heat:	SAME (1) <	F1 The number is for 1. heat
	NEXT (2)	F2 The number is for 2. heat
Continue: ENTER		

- Press <F1> and <ENTER> to select and confirm the same heat.
- Re-synchronize timing device or use internal clock as time of day.
- The timing device is ready.

3.1.3 Second (next) heat

Up to 256 heats can be carried out. In every heat the total time from the previous heats as well as the current heat are saved. There are two possibilities to switch to the next heat:

- Turn off TdC 8001 and on again
- Change heat in the main menu (see chapter 0).
- For every competitor the following times are printed:

0012	SZ	10:07:04.640	Start time (time of day)
	ZZ	10:08:35.150	Finish time (time of day)
	LZ	1:30.50	Run time
	MZ	1:32.38	Memory time
	TZ	3:02.88	Total time

In the main menu (menu 8) you can set if the time starts at zero or at the total time of previous heats. After crossing the finish line display (7) first shows run time, then total time or first total time, then run time and again total time. Set the display time for the run time and total time in main menu (menu 4/5).

Change heat in main menu

Advantage: no re-synchronization necessary; all preset value are stored.

Disadvantage: In case of long breaks in between heats the device is always activated. I. e. the longer the break the more time deviation happens. Without connected mains supply, energy from the batteries is spent.

- Press <ALT> and <MENU> at the same time.
- Select "Change heat" in menu 24 with the cursor.

Menu 24: CHANGE HEAT
Select: YES/NO or Menu number: 24

- Press <YES>

Select heat:	SAME (1) <	F1 continue in same heat
	NEXT (2)	F2 next heat
Continue: ENTER		

- Select next heat with <F2> + <ENTER>. The number in parentheses shows the heat number.

Start order:	START NUMBER <	F1
	BIBO WITHOUT GROUPS	F2
	BIBO WITH GROUPS	F3
Continue: ENTER		

3.2 Keypad Functions

The TdC 8001 has three keypads:

- start keypad (12)
- finish keypad (8)
- function keypad (9)

Because of this layout, two persons can work at the TdC 8001 at the same time. One person can execute the start while the second person is responsible for the finish. The start keypad is assigned to display (1), the finish keypad to displays (5) and (6). The function keypad has functions that can be used with both start and finish keypad. Information is shown on info display (7).

3.2.1 Start Keypad (12)



Manual start impulse (SZM at printer Drucker, COM at RS232), precision only 1/1200 seconds



The start time of the set start number on start display (1) is cleared. Pressing both keys <ALT> and <CLEAR> at the same time restores the cleared start time.



As long as key <BLOCK> is pressed, all start impulses (channel 0) are indicated as invalid and output with question mark. As long as keys <ALT> and <BLOCK> are pressed at the same time, all start impulses (channel 0) are ignored.



Keys to enter the start number at the start. The start number is shown on start display (1).



For entering (editing) the start time of the set start number on start display (1). In order to go to the input menu the keys <MENU> and >INPUT> have to be pressed at the same time. You can enter "Single" or "Interval".



Every start number input must be confirmed with <ENTER>. According to the segment shown in display (1) the start number counts automatically up or down or has to be done manually.

3.2.2 Finish Keypad (8)



Manual stop impulse (channel ZZM at printer, C1M at RS232), precision only 1/100 seconds



The finish time of the start number shown on finish display (6) is cleared. Pressing <ALT> and <CLEAR> at the same time restores the cleared finish time.



As long as <BLOCK> is pressed, all finish impulses (channel 1) are indicated as invalid and output with a question mark. The run time does not stop. As long as <ALT> and <BLOCK> are pressed, all finish impulses (channel 1) are ignored.



Keys to enter the start number in the finish. The start number is shown on the finish display (6).



For entering (editin) the finish time of the set start number on the finish display (6), press <MENU> and <INPUT> at the same time to go to the input menu for run times, memory times and intermediate times.



Confirm every input of start numbers with <ENTER>. Start number stepping upwards: <ENTER>, start number stepping downwards: <ALT> and <ENTER>

3.2.3 Function Keypad (9)



YES

Key for confirmation of YES/NO question.



NO

Key for denial of YES/NO question.



PRINT

When pressing <PRINT> the printer switches to buffer mode, i. e. all printer information is saved. Pressing <PRINT> again, all saved data is printed. This function is used during paper exchange. Pressing <ALT> and <PRINT> at the same time, turns the printer off. All information for the printer is lost. Press <PRINT> or <ALT> and <PRINT> again turns the printer on again. Press <MENU> and <PRINT> at the same time to print all settings of the main menu.



TEST

System test (see 2.10)



*

Setting start number stepping: * and + automatically up, * and * manual, * and – automatically down



CLASS

Printing the ranking



^

Cursor key up



v

Cursor key down



ALT

For activating second function always first press <ALT>, functions with <CLEAR>, <BLOCK>, <MENU> and <PRINT>.



MENU

Always press this together with another key; works with <ALT>, <INPUT>, <PRINT>, or <BLOCK>. In order to switch to the main menu press <ALT> and <MENU>



F1

Function key 1: selecting if in the info display (7) text is shown right-aligned in the first line



F2

Function key 2: selecting if in the info display (7) text is shown right-aligned in second line



F3

Function key 3: selecting if in the info display (7) text is shown right-aligned in the third line



F4

Function key 4: selecting if in the info display (7) text is shown right-aligned in the fourth line



MEMO

Buffer for mass arrival at the finish or at an intermediate time (see chapter 4.4)

3.3 Start Mode

There are three different start modes:

- **Single start:** every competitor has a separate start time
- **Group start:** every group has a separate start time (within the group one start time)
- **Mass start:** all competitors start at the same time (same start time)

You can set the mode of the automatic stepping with menu 53. The set value is also indicated on the start display by a beam.

Beam functions:

- At the top: after the start the start number jumps up to the next start number that has not yet started
- In the middle: manual mode, every start number has to be entered with the start keypad (12)
- At the bottom: after the start the start number jumps down to the next start number that has not yet started

ATTENTION: Set the start number in the start display on 0 to deactivate the automatic stepping.

3.3.1 Single Start

Every competitor has a separate start time, i.e. one competitor starts after the other. The output mode of the info display (7) can be set for single starts (see menu 7: info display).

3.3.1.1 Start Procedure for 1. Heat:

The start procedure can be atomized if the start order corresponds to the start numbers.

Start numbers count automatically up after every start:

- Set menu 53 on upwards (setting is shown on display (2))
- Display (1) shows 1 as start number
- After every further start, the start number is increased (automatically to the next number that has not yet started)
- A manual correction is always possible. Press <ENTER> to increase the start number.
- Display (1) shows a “b” next to the start number if this one is started.

Start numbers count automatically down after every start:

- Set menu 53 on downwards (setting is shown on display (2))
- Display (1) shows 1 as start number
- Set start number that starts first (e. g. 48) and confirm with <ENTER>
- After the start, the start number is decreased (automatically to the next number that has not yet started)
- A manual correction is always possible. Press <ENTER> to decrease the start number.
- Display (1) shows a “b” next to the start number if this one is started.

Manual start number input:

- Set menu 53 on middle (setting is shown on display (2))
- Enter start number with keypad (12) that starts first (e. g. 12) and confirm with <ENTER>
- After the start, a “b” shows next to the start number indicating that it has started
- Enter next start number and confirm with <ENTER>.
- After the start, a “b” shows next to the start number indicating that it has started

3.3.2 Start Procedure for 2nd Heat

The start procedure for 3., 4. and all further heats are carried out the same way as the 2. Menu 53 has the same function as for the 1. heat. In case Bibo is used, counting up has to be set. For the 2. heat the following is shown during activation process:

Start order:	START NUMBER <	F1
	BIBO WITHOUT GROUPS	F2
	BIBO WITH GROUPS	F3
Continue: ENTER		F4

Select the start order with <F1>, <F2> or <F3>.

- Start number:

The start order works just as the 1. heat, depending on settings of start number stepping.

- Bibo without groups:

The Bibo rule originates from alpine skiing: For competitions with two or more heats, the start order is set according to the ranking of the first (previous) heat, except for a certain number of competitors.

- | | |
|---------------------------|------------------------------|
| - Rank 15 starts first | - |
| - Rank 14 starts second | - Rank 16 starts sixteenth |
| - and so on | - Rank 17 starts seventeenth |
| - Rank 1 starts fifteenth | - and so on |

You can enter the number of competitors that are to be inverted. The preset value according to FIS regulation is 15.

- Bibo with groups:

The number of competitors to be inverted can be entered for every group separately. The preset value is 15. Basis for the Bibo rule is the group ranking of the first (previous) heat.

For example: three groups have been entered

Invert:	Gr 1: 15	enter number of competitors to be inverted
	Gr 2: 15	and confirm with <ENTER>
	Gr 3: 15	
Save with: ENTER		

ATTENTION: „Bibo with groups“ only works for the 2. (next) heat if groups is set for the 1. heat; start number stepping has to be set to upwards.

3.3.3 Group Start

Every group starts jointly with one start time. For the group start, groups should be entered. Enter the groups either after turning on in the activation menu or later in the main menu (menu 23: groups).

With no groups, the first start is valid for start numbers 1 to 9999.

Start times cannot be cleared with <CLEAR> of the start keypad as then all start times of the group are cleared. Corrections of the start time are executed with <MENU> and <INPUT> of the start keypad for the complete group.

3.3.4 Mass Start

All competitors start with the same start time (numbers 0001 to 9999). It is recommended to work with “ABSOLUTE TIMING” for mass starts with many competitors. In this way per competitor only one time is saved (no intermediate times). You cannot clear any start time with <CLEAR> as then all start times would be cleared. Correction of the start time can be executed with <INPUT> (start keypad).

4 Special Functions

4.1 Test – Check TdC 8001

See chapter 6.13

4.2 Block – Deactivate Impulse Channels

Every channel (C0 - C9) can be activated/ deactivated. Two possibilities exist to deactivate a channel:

- The deactivated channel ignores any impulse; the time is not recorded (channel off)
- The deactivated channel marks every impulse as invalid (with ?), saves and prints the time. Nothing is displayed on the scoreboard.

The channels 0 and 1 can be activated and deactivated directly.

4.2.1 Block Start

- As long as <BLOCK> of the start keypad (12) is pressed, all start impulses (channel 0) are invalid and indicated with ?.

```
Printer:           ?0043 SZ      10:34:13.384
Display Board:    no output
RS232:           ?0043 C0      10:34:13.384(CR)
```

- As long as <ALT> and <BLOCK> of the start keypad (12) are both pressed, all start impulses (channel 0) are ignored. No times are saved or output. A blocked start impulse does not trigger the time.

4.2.2 Block Finish

- As long as <BLOCK> of the finish keypad (8) is pressed, all finish impulses (channel 1) are invalid and indicated with ?. The clock does not stop and no run time is saved.

```
Printer:           ?0043 ZZ      10:34:13.384
Display Board:    no output
RS232:           ?0043 C1      10:34:13.384(CR)
```

- As long as <ALT> and <BLOCK> of the finish keypad (8) are both pressed, all finish impulses (channel 1) are ignored. No times are saved or output; no output on the scoreboard if a stop impulse is triggered while pressing <BLOCK>.

4.2.3 Individual Setting of Channels

All 10 channels can be activated or deactivated individually. All channels are activated when turning on. (Exception: continuation in a heat or selection of the next heat.)

- Pressing both <MENU> and <BLOCK> shows the state of all channels in info display (7).
- Select the desired channel with and .
- Change state of channel with F1
- (+) means the channel is activated
- (-) means the channel is deactivated
- Leave the menu by pressing both <MENU> and <BLOCK>

Example for display on info display (7):

channels on (+)/off (-):	CHANGE	F1
+	+	F2
+	+	F3
+	+	F4
+	+	F4
+	+	F4
+	+	F4
+	+	F4
+	+	F4
+	+	F4
c0	c1	c2
c3	c4	c5
c6	c7	c8
c9		

The above shown setting is always this after turning on the device (if not a further heat was selected). The below example show channel c3 and c4 deactivated.

channels on (+)/off (-):	CHANGE	F1
+	+	F2
+	-	F3
+	-	F3
+	+	F4
+	+	F4
+	+	F4
+	+	F4
+	+	F4
+	+	F4
c0	c1	c2
c3	c4	c5
c6	c7	c8
c9		

4.3 Edit Times

4.3.1 Edit Start Times

4.3.1.1 Clear Start Time

- <CLEAR> on the start keypad (12) clears the start time for the set start number shown on display (1).
- The start times of this start number is shown with c as cleared in the memory and print out.
- The RS232 interface sends the following: c0043 C0 10:34:13.384

4.3.1.2 Restore Cleared Start Time

- Key combination <ALT> and <CLEAR> of the start keypad (12) restores the cleared start time for the start number shown on display (1).
- The time of this start number is now saved as valid start time in the memory.
- The printer prints the start time as valid start time.
- The RS232 interface sends the following: 0043 C0 10:34:13.384

4.3.1.3 Edit Start Time

Press <INPUT> of the start keypad (12) to edit the start time of the start number shown on display (1). The following possibilities for editing are available:

- Overwrite the start time with the start keypad (12)
- Copy the start time to another start number
- Change invalid start time to valid start time

Input functions:

- Press <INPUT> of start keypad (12)
- Info display (7) shows the current start time of the start number shown on start display (1):

Input: 0015	C0	13:15:35.486	NEW No	F1	e. g. start number 15
-------------	----	--------------	--------	----	-----------------------

- The last digit of the start number blinks, change or confirm with <ENTER>.
- For changing the start number enter a new number or select one with \uparrow and \downarrow .
- Confirm with <ENTER> when the correct number shows (start keypad 12).
- The cursor is now on the first digit of the time in the first line. In case several times exist for this start number, the info display shows for example as follows:

Input: 0015	C0	13:15:35.486<	NEW No	F1	valid time
c0015	C0	13:10:12.498			cleared time
?0015	C0	13:17:28.938			invalid time

- The last digit of the start number blinks. Change or confirm <ENTER>.
- You can overwrite the first time with the number keys of the start keypad (12) (manual input of start time).
- Select correct time with \uparrow and \downarrow . With <ENTER> confirm this time as valid.
- If the marked time should also be assigned to another start number, press F1 and enter the new start number.
- Leave the INPUT Menu with pressing <INPUT> on start keypad (12).

Attention: If start time 00:00:00.000 is displayed, no start time has been assigned to this start number yet. Overwritten start times are marked with c, e. g.: c0009 ST 12:13:21.115

Group start: The input of group start times is just as for single start times. Instead of the start number the group is shown on display (1). The input always applies for all start numbers of the group.

4.3.1.4 Enter Start Times (Start Intervals)

For many sports the start times are already determined before the race, i. e. you can enter the start times in advance. Press both <MENU> and <INPUT> to go to the menu for entering the start times.

If the competitors start in regular intervals or at the same time, the start times can easily be entered:

- Press both <MENU> and <INPUT>.
- The following appears on info display (7):

```
Start interval from no:   001 to no: 002
                        Start time: 10:00:00.000
                        Interval: 00:01:00.000
Continue: ENTER
```

- Enter first and last start number for times with the same interval.
- Enter start time for the first start number.
- Enter interval time (interval from start number to start number). If interval time is 00:00:00.000 it is a mass start for all entered start numbers.

Attention: If the start times are input before the start and the start is delayed you have to enter the start times again. If the same start numbers are entered in different groups, always the latest input is valid. For example: input of start numbers 1 to 10, start time 10:00 hrs, interval time one minute

```
Start interval from no:   001 to no: 010
                        Start time: 10:00:00.000
                        Interval: 00:01:00.000
Continue: ENTER
```

This results in the following start times

- start number 1 – 10:00 hrs
- start number 2 – 10:01 hrs
- etc.
- start number 10 – 10:09 hrs



Attention: If the competitors start with irregular intervals, enter the data with <INPUT> of the start keypad (12) (e. g. Nordic Combined – Gunderson method).

4.3.2.4 Edit Run, Memory and Intermediate Times

In order to enter the edit menu for run, memory and intermediate times, press both <MENU> and <INPUT> (of finish keypad 8).

- Press both <MENU> and <INPUT>.
- The following shows on the info display (7):

Input times:	RUN TIME<	F1 change the run time
	MEMORY TIME	F2 change the memory time
	INTERMEDIATE TIME	F3 change intermediate time
Continue: ENTER		

- Select desired time with F1, F2, F3 or  and .
- Execute the changes as described in the following three chapters.
- Press both <MENU> and <INPUT> to leave the menu.

4.3.2.4.1 Change Run Time



You can edit the following:

- Overwriting the run time with finish keypad (12)
- Copy run time to another start number
- Disqualify a competitor

Change run times:

- Press both <MENU> and <INPUT>
- Press <F1> and then <ENTER>
- The info display show the current run time of the start number shown on finish display (6):

Input: 0015 RT 00:01:35.139	NEW No	F1 e. g. start number 15 F2
	DISQU.	

- The cursor blinks at the last digit of the start number.
- For editing another start number input it directly or select with  and .
- When the correct start number shows, press <ENTER> (finish keypad 8).
- If this start number already has several times, the info display (7) shows as follows:

Input: 0015 LZ 00:01:35.139	NEW No	F1 The currently valid time can be F2 overwritten.
	DISQU.	

- You can overwrite the time with the number keys of keypad (8) (manual input of run time).
- If you want to assign the marked run time also to another start number, press <F1> and input the new start number.
- You can disqualify a competitor with <F2>; start, finish and run time of the disqualified competitor are invalidated.
- Leave the menu by pressing both <MENU> and <INPUT> on finish keypad (8).

Attention: A run time of 00:00:00.00 means that no finish time has been assigned to this start number yet. An overwritten run time is marked with c, e. g. c0009 LZ 00:01:35.139

4.4 Memo – Buffer for Mass Finish

In case several competitors reach the finish at the same time, start numbers cannot be entered as fast as the stop impulses are received. In this case use the MEMO key. Before the first competitor of a throng reaches the finish press MEMO. The start number can now be entered later on.

- Throng of competitors have nearly reached the finish; press <MEMO>
- Start numbers of the competitors have to be noted in the correct order.
- All times of the competitors are saved with continuous numbers.
- The time is printed with an „m“.

RS232 Output	m####xCCCxHH:MM:SS.zhtqxGR(CR)
Printer Output	m####xCCCxHH:MM:SS.zht
m	Sign for memory time
####	all memory times are output with continuous numbers
CCC	channel (e. g. C1 for finish time, C1M for manual finish time)
HH:MM:SS.zhtq	time in 1/10,000 seconds for RS232
HH:MM:SS.zht	time in 1/1,000 seconds for RS232
GR	Group
x	blank
(CR)	Carriage Return

Assign numbers to the stored times:



The start numbers can be assigned to the competitors of the throng later on. This input can also be executed during the finish arrival.

- The info display shows as follows:

Memo: 1 C1 13:05:11.3451 No: _	first time in memory, channel 1
2 C1 13:05:12.3892	second time in memory, channel 1
3 C2 13:05:15.9848	third time in memory, channel 2
4 4 C1 13:05:15.4566	fourth time in memory, channel1

- Figure 4 in the bottom left corner signifies that four times are saved in the memory.
- The cursor is in the first line ready for entering the start number.
- Enter start number (finish keypad (8)), e. g. start number 34
- Confirm start number with <ENTER>
- The line into which the number was entered vanishes and the next time moves to the first line.

Memo: 2 C1 13:05:12.3892 No: _	second time in memory, channel 1
3 C2 13:05:15.9848	third time in memory, channel 2
4 C1 13:05:15.4566	fourth time in memory, channel 1
3	

- Enter start number (finish keypad (8)), e. g. start number 12
- Confirm start number with <ENTER>
- The line into which the number was entered vanishes and the next time moves to the first line.
- You can move the times with  and  up or down
- Enter all start numbers as described above.
- Exit by pressing <MEMO>

Two competitors are only once registered by the photocell:

In the memo mode two competitors arrive at the finish but the photocell is only once triggered (e. g. the competitors obstruct each other, i. e. the photocell is only interrupted once)

Memo: 1 C1 13:05:11.3453 No: _	first time in memory, channel 1
1	

- Enter start number (finish keypad 8), e. g. start number 55
- Confirm start number with <INPUT>

- The entered start number with corresponding time is saved and printed
- The same time is still on the info display (7):

Memo: 1 C1 13:05:11.3453 No: _ 1	first time in memory, channel 1
---	---------------------------------

- Enter start number (finish keypad 8), e. g. start number 10
- Confirm start number with <ENTER>
- The entered line vanishes and the MEMO memory is empty
- Exit by pressing <MEMO>

Attention: You can exit the MEMO menu at any time (press <MEMO>) and arrivals can be edited. In order to process the MEMO memory, press <MEMO> and enter the start numbers.

A wrong time can be cleared from the MEMO memory with <CLEAR> of the finish keypad (8).

Every memory time is shown and output with consecutive number. This helps to find times later on. In case times are cleared with <CLEAR>, they can be found in <INPUT> under start number 0.

With <CLEAR> cleared memo times are marked with a capital "C".

With <CLEAR> cleared run times are marked with a small "c".

4.5 Class – Print Ranking

4.5.1 Ranking in 1st Heat

Press <CLASS> to print a ranking of the race. It is requested if race points should be calculated. When printing a ranking it is at the same time output via RS232 interface and display interface. The ranking for the 1st heat looks as follows on the printer:

1.				1 st rank
0003	RT	0:49.52		start number 3 and run time
2.				2 nd rank
0011	RT	0:49.69		start number 11 and run time
3.				3 rd rank
0008	RT	0:50.02		start number 8 and run time

The ranking for the 2nd heat (and following heats) looks as follows on the printer:

1.				1 st rank
0011	RT	0:50.12		start number 11 and run time
	MT	0:49.69		memory time
	TT	1:39.81		total time
2.				2 nd rank
0003	RT	0:50.69		start number 3 and run time
	MT	0:49.52		memory time
	TT	1:40.21		total time
3.				3 rd rank
0008	RT	0:50.72		start number 8 and run time
	MT	0:50.02		memory time
	TT	1:40.74		total time

Press <CLASS> and the following appears on info display (7):

Classement:	ALL<	F1
	GROUPS	F2
	CLASSES	F3
Continue: ENTER	SINGLE	F4

Press six times , the following appears:

Classement:	SINGLE	F1
	FIRST TEN	F2
	NOT FINISHED	F3
Continue: ENTER	ADD<	F4

Press three times , the following appears:

Classement:	ADD	F1
	DISQUALIFIED	F2
	START ORDER	F3
Continue: ENTER	PROTOCOL	F4

- Ten different rankings are available.
- Select by and or <F1> to <F4>. When desired ranking is selected, press <ENTER>.
- Select if a result of run or intermediate time shall be printed:

Classement:	RUN TIME	F1 ranking of run times is printed
	INTERMEDIATE TIME	F2 ranking of intermediate times is printed
Continue: ENTER		

- Select if race points shall be calculated (for alpine or Nordic skiing):

```

Classement:          NO RACE POINTS<  F1
                   RACE POINTS BEST TIME  F2
                   RACE POINTS START NUMBER  F3
Continue: ENTER
  
```

- <F1> + <ENTER>: no race points are calculated
- <F2> + <ENTER>: for times of more than 30 seconds race points are calculated, reference time is the fastest time
- <F3> + <ENTER>: for times of more than 30 seconds race points are calculated, reference time is the time of the input start number

```

Classement:          ALL<  F1
                   SINGLE  F2
Continue: ENTER
  
```

ALL: ranking of all entered groups. The groups must be entered before (see chapter 3.1, 0; menu 23)

SINGLE: ranking of any group. The group number must be entered. If several groups shall be printed, enter the group, press <ENTER>, enter the next group, etc. When the last group is input, press <ENTER> once more.

```

Classement:          Gr: 0
Continue: ENTER
  
```

Classes: With the class evaluation there are numerous possibilities to issue an individual ranking. Any kind of evaluation groups can be arranged. You can also combine or further divide groups. Another important application is that late entries at the groups are possible (start numbers are not subsequent), so that it can be ranked.

All input for the classes is via finish keypad (8).

```

Classement:          No: 0> 0
Save with: ENTER
  
```

For classes always enter first and last start number. Confirm every start number with <ENTER> (finish keypad 8). Several start number blocks can be combined to one class.

```

Classement:          No: 4 > 10
                   No: 21 > 25
                   No: 51 > 55
Save with: ENTER
  
```

Terminate the input with pressing <ENTER> twice. In above example the ranking would contain the following start numbers: 4-10, 21-25 and 51-55

Single: A ranking of single start numbers is possible, e. g. for ranking within a team.

```

Classement:          No: _
Save with: ENTER
  
```

- Enter start numbers that you want to have in the ranking, e. g. 12 <ENTER>, 24 <ENTER>, 134 <ENTER>, 53 <ENTER>
- The info display (7) shows:

Classement:	No: 12
	No: 24
	No: 134
Save with: ENTER	No: 53

- When all start number are input, press <ENTER>.
- Select if the output of the ranking is with or without race points
- A ranking of start numbers 12, 24, 53 and 134 is printed
- The same ranking is output via RS232 interface

First Ten: A ranking of the first 10 ranks is issued.

Classement:		
	RUN TIME	
		FIRST TEN
		1.
0009	RT	1:30.45
		2.
0014	RT	1:30.56
etc.		
		9.
0002	RT	1:31.69
		10.
0020	RT	1:31.99

Not Finished: All start numbers are printed that have a start time but no finish time

Classement:	
	RUN TIME
	NOT FINISHED
0004	
0028	
0052	
0109	

Add: Adding any number of times is possible. The added time is used to issue a team ranking.

Classement:	No: _
Continue: ENTER	

- Enter start numbers that you want in the ranking, e. g. 9 <ENTER> 14 <ENTER> 72 <ENTER> 102 <ENTER>
- The info display (7) shows:

Classement:	No: 9
	No: 14
	No: 72
Continue: ENTER	No: 102

- When all start numbers are entered, press <ENTER>
- The times of start numbers 9, 14, 72 and 102 are printed.
- The times are added and printed.

```

Classement :

      RUN TIME
      ADD

0009 RT      1:31.45
0014 RT      1:30.09
0072 RT      1:33.41
0102 RT      1:35.69
ADD          6:10.64
  
```

sum of the times

Disqualified: All start numbers disqualified via <INPUT> of the finish keypad (8) are printed.

```

Classement :

      DISQUALIFIED

      0007
      0024
      0107
  
```

Start order: If you are in 2nd heat (or higher) you can print the start order for the current heat. The start order is especially interesting if you apply the Bibo regulation.

Protocol: The protocol is always printed in storage order. It can be printed for the following times:

- Start time
- Finish time
- Intermediate time
- Run time

With the cursor (< or >) select the time that is to be printed:

```

Classement :          START TIME<  F1
                   FINISH TIME  F2
                   INTERMEDIATE TIME F3
Continue: ENTER          RUN TIME  F4
  
```

With <F1> all, with <F2> a part of the selected times can be printed.

```

Classement :          ALL<  F1
                   SINGLE  F2
Continue: ENTER
  
```

In case of selection SINGLE the start numbers have to be entered (from – to) that are to be printed. Several blocks can be entered. Confirm with two times <ENTER>.

```

Classement :          No: 0  0
Continue: ENTER
  
```

4.5.2 Ranking in 2nd heat

For the ranking in 2nd heat (or a following one) the following rankings are available:

```

Classement :          TOTAL TIME <  F1
                   RUN TIME        F2
                   MEMORY TIME     F3
Continue: ENTER  INTERMEDIATE TIME F4
  
```

- Total time: a ranking ordered by total time is generated
- Run time: a ranking ordered by run time is generated
- Memory time: a ranking ordered by memory time is generated
- Intermediate time: a ranking of any intermediate time (c2 to c9) is generated

Select with F1, F2, F3 or F4.

4.5.3 Race Points

For the ranking of SPLIT the race points for alpine or Nordic skiing can be calculated. Race point for alpine skiing can only be calculated if the run time is more than 30 seconds.

```

Classement:      NO RACE POINTS < F1
                 RACE POINTS BEST TIME F2
                 RACE POINTS START NUMBER F3
Continue: ENTER
    
```

- <F2> selects race point calculation; race points based on best time are calculated
- <F3> selects race point calculation; race points based on times of start numbers is calculated

```

Classement:      No: 0
Save with: ENTER
    
```

- In order to calculate race points for groups or classes, first the fastest time has to be entered.
- Every discipline has a certain F factor that has to be input:

```

Classement:      F-Factor: _
Continue: ENTER
    
```

The printout with race point calculation for an alpine skiing race looks like this:

<pre> 1. 0003 RT 1:49.52 RP 00000.00 2. 0011 RT 1:49.69 RP 00012.34 3. 0017 RT 1:50.69 RP 00032.34 </pre>	<pre> 1st rank start number 3 and run time race points for StNo 3 2nd rank start number 11 and run time race points for StNo 11 3rd rank start number 17 and run time race points for StNo 17 </pre>
---	---

4.6 Print – Turn Printer On or Off

The printer is automatically activated during activation process of the TdC 8001. After turning on the following setting for the printer are available with <PRINT>:

Print mode: all printer data is printed
 Buffer mode: all printer data is saved but not printed. Use this during paper replacement.

- Press <PRINT>
- Printer in buffer mode, i. e. all printer data is saved
- Press <PRINT>
- Printer in print mode, the data saved in the meantime is now printed.

Turn printer off: Printer is off, sent data is lost

- Press <ALT> and <PRINT>
- Printer is off
- Press <PRINT>
- Printer is on, all newly received data is printed

5 Main Menu – General Settings



If settings are changed in the main menu, most of the changes are stored even after turning off. Settings of the main menu apply for all programs.

5.1 Restoring the Default Settings

- Turn device off (switch g)
- Keep <ALT> and <MENU> pressed.
- Turn device on (switch g)
- After 5 seconds let go of <ALT> and <MENU>
- The default settings are active once more.

Settings of the main menu can be inquired and edited via RS232 interface (see chapters 8.2.1, 8.2.2).

5.2 Open Main Menu

- Select program
- Press <ALT> and <MENU> at the same time.
- You can browse the menu with  and . Directly select any sub program with the numeric keys of finish keypad (8).
- Enter the displayed menu with <YES>.

5.3 Main Menu – Brief Description

Menu 1	(p. 41):Delay time start = 1.00 sAdjustable: 0.01 to 9.99 seconds
Menu 2	(p. 41):Delay time finish = 0.30 sAdjustable: 0.01 to 9.99 seconds
Menu 3	(p. 41):Seconds mode = OFFAdjustable: ON or OFF
Menu 4	(p. 41):Display time 1 = 03 sAdjustable: 0 to 99 seconds
Menu 5	(p. 42):Display time 2 = 03 sAdjustable: 0 to 99 seconds
Menu 6	(p. 42):Display thousandth = OFFAdjustable: ON or OFF
Menu 7	(p. 42):Info display = STARTAdjustable: START, FINISH or OFF
Menu 8	(p. 42):Running time = RUNAdjustable: RUN or TOTAL
Menu 9	(p. 42):Running tenth = OFFAdjustable: ON or OFF
Menu 10	(p. 43):Intermediate time rank = ONAdjustable: ON or OFF
Menu 11	(p. 43):Run time rank = ONAdjustable: ON or OFF
Menu 12	(p. 43):STNO automatic = OFFAdjustable: START, FINISH or OFF
Menu 13	(p. 43):Automatic time = 00:00:00.00Adjustable: any odd time
Menu 14	(p. 43):Print start time = OFFAdjustable: ON or OFF
Menu 15	(p. 43):Print menus = ONAdjustable: ON or OFF
Menu 16	(p. 44):Printer linefeed = 0Adjustable: 0 to 9
Menu 17	(p. 44):RS-232 baud rate = 9600 BdAdjustable: 2400, 4800 or 9600 baud
Menu 18	(p. 44):RS-232 run time = OFFAdjustable: ON or OFF
Menu 19	(p. 44):D-Board baud rate = 2400 Bdno function yet
Menu 20	(p. 44):D-Board channel 2 = RUNNINGAdjustable: RUNNING or STANDING
Menu 21	(p. 44):Beep = ONAdjustable: ON or OFF
Menu 22	(p. 45):Handicap time = 00:00:00.00Adjustable: enter handicap time
Menu 23	(p. 45):Groups = OFFdepending on number of entered groups
Menu 24	(p. 45):Change heatAdjustable: SAME or NEXT
Menu 25	(p. 45):Change racechanging to another race possible
Menu 26	(p. 45):D-Board-test = OFFtest program for display board
Menu 27	(p. 46):ID channel 4 = b (blue)Adjustable b (blue) or L (left)
Menu 28	(p. 46):Penalty time = 1.500 sAdjustable: 0.000 to 9.999
Menu 29	(p. 46):Start channel = SEPARATEAdjustable: SEPARATE or COMMON
Menu 30	(p. 46):Rank calculation = SEPARATEAdjustable: SEPARATE or COMMON
Menu 31	(p. 47):Print times = ONAdjustable: ON or OFF
Menu 32	(p. 47):Distance = 100 mAdjustable: 1 to 9999 m
Menu 33	(p. 47):Measuring unit = km/hAdjustable: km/h, m/s or mph
Menu 34	(p. 47):Minimum speed = 10 km/hAdjustable: 1 to 9999
Menu 35	(p. 47):Maximum speed = 200 km/hAdjustable: 1 to 9999
Menu 36	(p. 48):Penalty points = 4.00Adjustable: 0.01 to 99.99

- Menu **37**, (p. 48): Time violation 1 = 0.25.....Adjustable: 0 to 99.99
- Menu **38**, (p. 48): Time violation 2 = 1Adjustable: 0 to 99.99
- Menu **39**, (S. 48): Parcour Time 1 = 000.00.....Adjustable: 0 bis 999.99
- Menu **40**, (S. 48): Parcour Time 2 = 000.00.....Adjustable: 0 bis 999.99
- Menu **41**, (p. 48): Block time 1 = 000.00Adjustable: 0 to 999.99
- Menu **42**, (p. 49): Block time 2 = 000.00Adjustable: 0 to 999.99
- Menu **43**, (p. 49): Countdown time 1 = 045.00Adjustable: 0 – 999.99 seconds
- Menu **44**, (p. 49): Countdown time 2 = 030.00Adjustable: 0 – 999.99 seconds
- Menu **45**, (p. 49): D-Board Count Down = ONAdjustable: ON or OFF
- Menu **46**, (S. 49): Time out signal = ONAdjustable: ON or OFF
- Menu **47**, (S. 49): Add PTM Immediately = OFFAdjustable: ON or OFF
- Menu **458**, (S. 49): .. Teams = OFFAdjustable: ON or OFF
- Menu **45**, (S. 49): Distance = 0Adjustable: 0 to 999999 m
- Menu **50**, (S. 49): Add Immediately = OFFAdjustable: ON or OFF
- Menu **51**, (S. 49): Speed Skating Track = 400 m.....Adjustable: 333, 400, 500 or any in Meter
- Menu **52**, (S. 49): was in the past to adjust the precision, now not used any more
- Menu **53**, (p. 49): BIB-Counting.....Adjustable: Manual, Up, Down
- Menu **54**, (S. 49): Time-Out = 000Adjustable: 0 to 999 seconds
- Menu **5553**, (S. 49): LED-Brightness = 9.....Adjustable: 1 to 9
- Menu **56**, (S. 49): Displaytime to next STNO = 3Adjustable: 1 to 9 seconds
- Menu **57**, (S. 49): ADD PTO immediately = ONAdjustable: ON or OFF
- Menu **58**, (S. 49): Latching Blockkeys = OFFAdjustable: ON or OFF
- Menu **59**, (S. 49): Pulse from Radio = all off.....Adjustable: ON or OFF
- Menu **53**, (S. 49): Startnumber-Info RS232 = OFF.....Adjustable: ON or OFF
- Menu **53**, (S. 49): Next SyncimpulseAdjustable: next full minute
- Menu **62**, (S. 49): Extern BeepAdjustable: Channel 0 to 9
- Menu **53**, (S. 49): RS485 User = Wireless TN.....Adjustable: WTN or Baudrate
- Menu **53**, (S. 49): Last Impuls Validity = 0.00Adjustable: 0 to 9.99 seconds

Delay time start:

Menu 1

Default = 1.00 s

The delay time can be set from 0.00 to 9.99 seconds. Use 0 to 9 of the finish keypad for input of new start delay time. Confirm with <ENTER>.

```
Menu 1:      DELAY TIME = 1.00 s
```

input of desired delay time

Save with: ENTER

confirm with <ENTER>

Delay time finish:

Menu 2

Default = 0.30 s

The finish delay time can be set from 0.00 to 9.99 seconds. Use 0 to 9 of the finish keypad for input of the new finish delay timeseconds eingestell werden. Confirm with <ENTER>.

```
Menu 2:      DELAY TIME = 0.30 s
```

input of desired delay time

Save with: ENTER

confirm with <ENTER>

Seconds mode:

Menu 3

Default = OFF

The seconds' mode usually is deactivated. When the seconds' mode is activated, the clock does not turn to 1 minute after 60 seconds but continues with 61, 62, 63 etc. This mode is necessary for certain sports.

```
Menu 3:      SECONDS MODE =      ON
                                     OFF<
```

F1 seconds mode activated
F2 time with hrs, min and sec
confirm selection with <ENTER>

Save with: ENTER

Display Time 1:

Menu 4

Default = 03 s

You can input the period of time that indicates for how long a stopped time (intermediate or run time) is shown on the display (5) and the scoreboard before the running time reappears.

```
Menu 4:      DISPLAY TIME 1 = 03 s
```

input seconds with finish keypad (8)

Save with: ENTER

save time with <ENTER>

Display Time 2:

Menu 5

Default = 03s

Period of time that indicates for how long the second time in the second heat (total or run time) is shown on display (5) and the scoreboard before the ranking disappears (or back to total time).

```
Menu 5: DISPLAY TIME 2 = 03 s
```

Save with: ENTER

input seconds with finish keypad (8)

save time with <ENTER>

Display Thousandth

Menu 6

Default = OFF

Usually the 1/1000 seconds are not shown on the display. If they are, the time display is shifted two digits to the left. No hours can be shown anymore. The thousandth can only be displayed if precision is set to thousandth.

```
Menu 6: DISPLAY THOUSANDTH ON
        OFF<
```

Save with: ENTER

F1 display 1/1000 sec

F2 display 1/100 sec

confirm selection with <ENTER>

Infodisplay

Menu 7

Default = START

Different displays can be set on the info display (7) during the timing.

```
Menu 7: INFO-DISPLAY START<
        FINISH
        OFF
```

Save with: ENTER

F1 display is start oriented

F2 display is finish oriented

F3 no display

confirm selection with <ENTER>

- Start: The info display always show the running times. This display only works in the program SPLIT for individual starts.
 - <F1> first time started
 - <F2> current time, last stopped time in first line of info display (7)
 - <F3> last time started
- Finish: The info display always shows the finish times. This display works for all start modes in program SPLIT.
 - <F1> first time with stop impulse (intermediate or finish time)
 - <F2> current time, last stopped time in first line of info display (7)
 - <F3> last time with stop impulse, fourth line of info display (7)
- Off: No times are shown in info display (7).

Running Time

Menu 8

Default = RUN

You can choose if the time starts at 0:00.00 or at total time in second and following heats.

e. g.: run time of 1st heat of start number 5 is 1:30.45

RUN: time starts in 2nd heat at 0:00.00, run time is shown in the finish

TOTAL: time starts in 2nd heat at 1:30.45, total time is shown in the finish

```
Menu 8: RUNNING TIME RUN<
        TOTAL
```

Save with: ENTER

F1 run time is displayed

F2 total time is displayed

confirm selection with <ENTER>

Running Tenth

Menu 9

Default = AUS

Display (5) and interface "Display Board" (e) can output running 1/10 seconds (the scoreboard cannot display 1/10 seconds). The running 1/10 is important if a video generator (TV) must be supplied. The display board GAZ is not able to show a running 10th.

```
Menu 9: RUNNING TENTH ON
        OFF<
```

Save with: ENTER

F1 running 1/10 activated

F2 running 1/10 deactivated

confirm selection with <ENTER>

Intermediate Time Rank

Menu 10

Default = OFF

Display (5) and scoreboard can show the rank for every intermediate time. The rank is always displayed for the period of “display time”. For using several intermediate times, every one of it must have its own channel (C2 to C9).

Menu 10:	INTERMEDIATE RANK	ON<
		OFF
Save with: ENTER		

F1 show rank
F2 do not show rank
confirm selection with <ENTER>

Run Time Rank

Menu 11

Default = ON

Display (5) and scoreboard can show the rank for every run or total time. The rank is always displayed for the period of “display time”.

Menu 11:	RUN TIME RANK	ON<
		OFF
Save with: ENTER		

F1 show rank
F2 do not show rank
confirm selection with <ENTER>

Start Number Automatic

Menu 12

Default = OFF

The start number input for start and finish can be executed automatically

- START: Only one competitor is allowed on the track. If the competitor has reached the finish, the next one can start. As long as the start numbers are counted up continuously, no start number has to be entered for neither start nor finish.
- FINISH: It is irrelevant how many competitors are on the track. The start number in start display (1) steps forward by one start number after every start impulse. The start number in finish display (6) steps forward by one start number after every finish impulse

Menu 12:	STNO AUTOMATIC	START<
		FINISH
		OFF
Save with: ENTER		

F1 start automatic activated
F2 finish automatic activated
F3 automatic deactivated
confirm selection with <ENTER>

Automatic Time

Menu 13

Default = 00:00:00.00

If the start number automatic is on finish, an automatic time can be set. If a competitor does not reach the finish before the end of the automatic time, the finish display automatically switches to the next started number.

Menu 13:	AUTOMATIC TIME = 00:00:00.00
Save with: ENTER	

confirm with <ENTER>

Print Start Time

Menu 14

Default = AUS

The start time can be printed right after the start. Typically, the start time is printed with finish and run time.

Menu 14:	PRINT START TIME	ON<
		OFF
Save with: ENTER		

F1 print start time immediately
F2 print start time with finish time
confirm selection with <ENTER>

Print Menus

Menu 15

Default = ON

Starting with **version V11.31** we do not have this menu any more. By pressing <MENU> and <PRINT> it is now possible to print the menu list.
Before version V11.31 menu 15 had the following functions. The menus are normally also printed (e.g. when turning on). This does not happen when “Print Menus” is off. The changes of settings in the main menu are neither printed.

Menu 15:	PRINT MENU	ON<
		OFF
Save with: ENTER		

F1 print menu settings
F2 do not print menu settings
confirm selection with <ENTER>

Printer Linefeed

Menu 16

Default = 0

The printer can make blank lines after a printed paragraph (e. g. two blank lines so that the printout moves across the tear-off edge). 1 to 9 blank lines can be set; if set to 0, in every line is printed.

```
Menu 16:  PRINTER LINEFEED = 0
```

enter number of blank lines

```
Save with: ENTER
```

confirm selection with <ENTER>

RS232 Baudrate

Menu 17

Default = 9600 BD

The baud rate for RS232 interface (d) can be set to 2400, 4800, 9600, 19200 Baud.

```
Menu 17:  RS-232 BAUDRATE      2400 Bd
```

F1

```
4800 Bd
```

F2

```
9600 Bd <
```

F3

```
Save with: ENTER
```

```
19200 Bd
```

F4

RS232 Run Time

Menu 18

Default = OFF

In difference time mode the stopped time of days is always output via RS232 interface (d). Additionally, the run time can be output.

```
Menu 18:  RS-232 RUN TIME      ON
                                     OFF <
```

F1 output of run time

F2 no output of run time

```
Save with: ENTER
```

confirm selection with <ENTER>

Display Board Baudrate

Menu 19

Default = 2400 Bd

The display board interface can be set to 2400, 4800, 9600 or 19200. For ALGE displays use 2400 Bd. Starting with version V13.31 it is possible to turn the interface off (disable). To disable press the <arrow key up> and then <F1>. With this version it sends the display board data also through RS485. Starting with version V14.91 is the baud rate not automatically on 2400. The last used baud rate will remain.

```
Menu 19:  D-BOARD BAUDRATE    2400 Bd
```

F1

```
4800 Bd
```

F2

```
9600 Bd <
```

F3

```
Save with: ENTER
```

```
19200 Bd
```

F4

Display Board channel 2

Menu 20

Default = RUNNING

The output can be set at channel 2 of the interface display board (e). Running time, standing times, or best times can be output. The best time is always from the group if groups are used. For displaying the best time the code switch of the display has to be set to position 2. A ranking is always output via the display board interface (e) at channel 2. Switch between channel 1 and 2 by turning the plug by 180°.

```
Menu 20:  D-BOARD CHANNEL 2   RUNNING <
                                     STANDING
                                     BEST TIME
```

F1 output of running time

F2 output of standing time

```
Save with: ENTER
```

F3 output of best time

Beep

Menu 21

Default = ON

The beep sounds at every timing impulse. The length of the beep depends on the length of the delay time. If the beep disturbs, it can be turned off. The beep is always activated after turning the device on.

```
Menu 21:  BEEP                ON
                                     OFF <
                                     WITH VALUED TIME
```

F1 beep activated

F2 beep deactivated

```
Save with: ENTER
```

Handicap Time

Menu 22

Default = 00:00:00.00

Percentage that indicates how much the measured time is faster or slower than the handicap time. The handicap is deactivated if not time is input (00:00:00.00).

```
Menu 22:   HANDICAP TIME = 00:00:00.00
```

enter handicap time
(no function yet)

```
Save with: ENTER
```

Printout:

```
0012  ST   10:58:11.320  start time
      FT   10:58:41.693  finish time
      RT    0:30.37      run time
HANDICAP:   +001.60%    handicap
```

Input of Groups

Menu 23

Default = OFF

For showing ranks withing groups, the groups have to be entered during turn-on procedure or later here. Already entered groups can be edited in this main menu.

```
Menu 23:   GROUPS      GR: 1> 0
```

enter last number of group

```
Save with: ENTER
```

confirm selection with <ENTER>

- Enter last start number of 1st group
- Press ENTER
- Enter last start number of 2nd group
- Press ENTER
- Continue identically until the last group
- After the last group confirm with 2 x ENTER

Attention: For post-nominations sufficient start numbers per group should stay vacant.

Change Heat

Menu 24

The TdC 8001 can stay turned-on to change the heat.

```
Menu 24:   SELECT HEAT
```

```
SAME (1) <
```

F1 continue in same heat

```
NEXT (2)
```

F2 select new heat

```
Continue: ENTER
```

exit with <ENTER>

Attention: If the next heat is selected you cannot return to previous heat.

Change Race

Menu 25

The TdC 8001 can stay turned on for changing from one race to another. With <YES> or <ENTER> a new race can be selected. The same menus as when switching-on appears. The previous synchronization is kept.

Display Board Test

Menu 26

Default = OFF

For testing the display board and for displaying the time of day, blank or ALGE during a break. In case the display board has digits that do not work properly, this test should be executed. If digits are defective the corresponding segments can be determined. The test with "eights" is recommended after a long still stand or at low temperatures.

With <F1> to <F4> the desired test mode can be set. An arrow in the display indicates the currently running GAZ test. There are a total of seven display possibilities. Abort the GAZ test with <ENTER>.

```
Menu 26:   D-BOARD-TEST
```

```
TIME <
```

F1 day time is displayed

```
ALGE
```

F2 ALGE is displayed

```
BLANK
```

F3 blank

```
Continue: ENTER
```

```
123456789
```

F4 test all 9 possible digits

Print Time Speed Measurement, Menu 31

Default = OFF

In program 7 speed measurement you can set if the time of days and net time of the speed measurement should also be printed.

Menu 31: PRINT TIMES

ON

F1 times and speed

OFF <

F2 only speed

Save with: ENTER

exit with <ENTER>

Print times = off:

0001 km/h	144.23
0002 km/h	120.08

Print times = on

0001	C0	13:49:41.8501
0001	C1	13:49:42.1001
	RT	0:00.2490
	km/h	144.23
0002	C0	13:59:45.2413
0002	C1	13:59:45.5413
	RT	0:00.2990
	km/h	120.08

Measuring Distance Speed Measurement, Menu 32

Default = 0100 m

The measuring distance between both photocells can be set between 1 and 9999 m. It is always entered in meter independent from the unit.

Menu 32: DISTANCE = 0100 m

input measuring distance

Save with: ENTER

exit with <ENTER>

Unit Speed Measurement

Menu 33

Default = km/h

Input the unit for speed measurement. Select from km/h, m/s and mph.

Menu 33: UNIT

kmh <

F1 kilometers per hour

mps

F2 meter per seconds

mph

F3 miles per hour

Save with: ENTER

exit with <ENTER>

Minimum Speed

Menu 34

Default = 0010 km/h

Input the minimum speed that should be measured. Every speed below this value is not valid. Input of 1 to 9999 is possible.

The unit of menu 33 also applies for this menu. The entered minimum speed is automatically converted into the new unit.

Menu 34: MIN.SPEED = 0010 kmh

enter minimum speed

Save with: ENTER

exit with <ENTER>

Maximum Speed

Menu 35

Default = 0200 km/h

Input the maximum speed that should be measured. Every speed exceeding the entered value is invalid. Input of 1 to 9999 is possible.

The unit of menu 33 also applies for this menu. The entered maximum speed is automatically converted into the new unit.

Menu 35: MAX.SPEED = 0200 kmh

enter maximum speed

Save with: ENTER

exit with <ENTER>

Penalty Points

Menu 36

Default = 04.00

Penalty points are imposed at show jumping. The standard penalty points for obstacle knockdown can be selected. Penalty Points from 0.01 to 99.99 are possible.

Menu 36: PENALTY POINTS = 04.00

preset penalty points

Save with: ENTER

exit with <ENTER>

Time Violation 1

Menu 37

Default = 0.25

Time violation points incur at show jumping. The points per started second time violation for the main course can be set between 00.00 and 99.99.

Menu 37: TIME VIOLATION = 00.25

preset time points

Save with: ENTER

exit with <ENTER>

Time Violation 2

Menu 38

Default = 1.00

Time violation points incur at show jumping. The points per started second time violation for jump-off course can be set between 0.00 and 99.99.

Menu 38: TIME VIOLATION= 01.00

preset time points

Save with: ENTER

exit with <ENTER>

Parcour Time 1

Menu 39

Default = 000.00

Parcour (course) time has to be entered for show jumping. If you do not input any parcour time no penalty points are added for time violation. The parcour time 1 applies to the main course (1st phase).

Menu 39: PARCOUR TIME 1 = 000.00

enter course time

Save with: ENTER

exit with <ENTER>

Parcour Time 2

Menu 40

Default = 000.00

See "Parcour Time 1". Parcour time 2 applies to 2nd phase.

Menu 40: PARCOUR TIME 2 = 000.00

enter course time

Save with: ENTER

exit with <ENTER>

Block Time 1

Menu 41

Default = 000.00

Enter block time for show jumping. During the block time a finish impulse of the finish photocell is evaluated as invalid. The time of day is printed with a question mark. The time stops neither on display (5) neither on the display board. Block time is for competition during which the rider passes the finish photocell before passing the finish. Block time 1 applies to main course (1st phase).

Menu 41: BLOCK TIME 1 = 000.00

block time

Save with: ENTER

exit with <ENTER>

Block Time 2

Menu 42

Default = 000.00

See "Block Time 1". Block time 2 applies to 2nd phase.

Menu 42: BLOCK TIME 2 = 000.00

preset time points

Save with: ENTER

exit with <ENTER>

Count Down Time 1

Menu 43

Default = 00:01:00.00

Countdown time for carving and show jumping can be entered (carving: 0 to 23:59:59.99, show jumping: 0 to 6399.99 seconds). This time applies to all participants (main course at show jumping).

```
Menu 43: COUNT DOWN TIME 1 = 00:01:00.00
```

enter countdown time

Save with: ENTER

exit with <ENTER>

Count Down Time 2

Menu 44

Default = 00:01:00.00

Countdown time for 2nd phase at show jumping can be entered. A time from 0 to 6399.99 is adjustable. This countdown time applies to all participants.

```
Menu 44: COUNT DOWN TIME 2 = 0030.00
```

enter countdown time

Save with: ENTER

exit with <ENTER>

Count Down for GAZ

Menu 45

Default = ON

Countdown for show jumping can be deactivated for display boards. If it is deactivated for the display board, all other countdown functions stay activated.

```
Menu 45: D-BOARD COUNT DOWN          ON <
                                         OFF
```

output to display board

no output on GAZ

Save with: ENTER

exit with <ENTER>

Time Out Signal

Menu 46

Default = ON

The tone signal output for the timeout you can switch on or off.

Add PTM immediately

Menu 47

Default = OFF

This menu is only for show jumping. PTM are penalty points caused through time violence. This menu has only influence for the data output for display boards. Setting the menu on ON it shows the penalty points when the time is running immediately. When OFF is activated it shows the PTM only after you add the result by pressing the key F3.

Teams

Menu 48

Default = OFF

This point is only for team show jumping events. If you select ON you can input the bibs of each team.

Distance

Menu 49

Default = 0

To input the race distance for the program Cycling. The distance is needed to calculate the average speed. You can input the distance between 0 and 999999 Meter.

Speed Skating Track

Menu 51

Default = 400 m

For speed skating you have to select the track length to calculate the amount of laps. You can select between 333, 400 and 500 m. Further you can input yourself the track length in meter.

Precision

Menu 52

This menu is not active any more. You must input the timing precision after you selected the program.

BIB Counting

Menu 53

Default = UP

You can select if the bib changes after a start. When selecting <MANUAL> you have to key in the next bib. When selecting <UP> after the start the bib changes to the next higher free bib (in the second run when using the BIBO it will change the bib to the next bib by bibo-rule). When selecting <DOWN> after the start the bib changes to the next lower free bib.

```
Menu 53: BIB COUNTING          UP <
                                MANUAL
                                DOWN
```

counting up

manual input

counting down

Save with: ENTER

exit with <ENTER>

Attention: Enter start number 0 with start keypad for fast deactivation of automatic counting; automatic counting is blocked.

Time Out

Menu 54

Default = 0 seconds

Used for show jumping and agility. When you input a time limit it disqualifies the competitor when this time is reached. The time is adjustable between 0 and 999 seconds. When using 0 there is no time limit.

LED-Brightness

Menu 55

Default = 9

When using LED-display boards from ALGE-TIMING you can adjust the brightness of the LED in 10 levels. The value 0 is relatively dark (e.g. when using it at night), the value 9 is the brightest (e.g. when you have sunshine).

```
Menu 55: LED-BRIGHTNESS = 9
```

Input: 0 to 9

```
Save with: ENTER
```

exit with <ENTER>

Displaytime to next StNo

Menu 56

Default = 3 seconds

After the start the bib will stay for the duration of the adjusted time before it changes to the next bib (only when using Automatic bib counting on UP or DOWN. This is important to avoid in case of double impulses that the next bib start by accident.

```
Menu 56: DISPLAYTIME TO NEXT STNO = 3
```

Input 0 to 9 seconds

```
Save with: ENTER
```

exit with <ENTER>

Add PTO Immediately

Menu 57

Default = OFF

The PTO is a penalty time that in show jumping that a competitor can get if the horse refuses to jump a barrier but the barrier drops. If you ADD PTO IMMEDIATELY, then it adds this penalty time already to the running time.

Latching Blockkeys

Menu 58

Default = OFF

Is used for show jumping and agility. When you select LATCHING BLOCKKEYS = ON, than you do not have to block permanent the block key for start and finish to avoid wrong timing impulses. If you press once on the BLOCK key you can activate the start or finish. When using the next bib the "Block-Mode" again active.

This menu has also a second selection with PRINT BLOCKTIMES. If you have this on ON it will print and store the time of day of "blocked" impulses (but the time will not stop).

```
Menu 58: LATCHING BLOCKKEYS = OFF
          PRINT BLOCKTIMES   = ON
```

Input ON or OFF

```
Change: YES/NO Save with: ENTER
```

Input ON or OFF

exit with <ENTER>

Pulse from Radio

Menu 59

Default = all OFF

When receiving impulses by radio (e.g. WTN or TED) it is possible to activate by selection <YES> for the channel that the time delay cause by the radio transmission (0.1 sec.) will be automatically corrected.

```
Menu 59: Pulse from Radio: Channel 0 = YES<
                               Channel 1 = NO
                               Channel 2 = NO
                               Channel 3 = NO
Save with: ENTER
```

Channel 0 is switched on

Channel 1 is switched off

Channel 2 is switched off

Channel 3 is switched off

Attention: Until version 13.31 this menu was called „Impulse from TED“.

Startnumber-Info RS232

Menu 60

Default = OFF

If this menu is active it will output two information through RS232 and RS485 when you input the bib for the start. As soon as you start to input a number it will output s0000. When you confirm the new bib with <ENTER> it will output sXXXX (XXXX = bib). The same happens at the input of a finish bib with n0000 and nXXXX.

When you use a mode that switches the bibs automatically it outputs only nXXXX or sXXXX.

This information about the bib goes also through the RS232 interface on channel 2.

Next Syncimpulse**Menu 61**

This function allows you to synchronize other timing devices with this TdC8001 (that is already running). When you select this menu it will output at the next full minute a sync impulse through channel 0 (C0). In order to sync another timing device start it and input the time of the next full minute and connect it through channel C0.

Extern Beep**Menu 62****Default = OFF**

You can select that through the channels with YES that you want to have a beep output through the an external speaker connected at socket (f).

RS485 User**Menu 63****Default = OFF**

You can select the adjustment of the interface RS485. When using the WTN (Wireless Timing Network), it will read delayed transmitted timing impulses and report a continuous blocked WTN channel. If you select the display board mode you have to select between three baud rates (2400, 9600, 19200)

Menu 63: RS485 USER

Wireless TN<

DB 2400 Bd

DB 9600 Bd

DB 19200 Bd

Save with: ENTER

WTN connected

Display Board with 2400 Baud

Display Board with 9600 Baud

Display Board with 19200 Baud

Last Impulse Validity**Menu 64****Default = 0.00 seconds**

For special timing use, e.g. when you have a team and the last impulse of a team member should be shown. If you input a time between 0.00 and 9.99 seconds it will not take the first impulse, but the impulse that has no other impulse during the time adjusted. If you adjust 0.00 seconds this function is not activated.

6 Programs

In order to select a program, turn on the TdC 8001. After about 5 seconds the program used last time is displayed. For selecting this program press <ENTER>.

For changing the programs directly enter the program number and press <ENTER>. You can also use **↑** and **↓**. Press them until the desired program is shown on info display (7); press <ENTER>.

The following programs can be selected:

Program	Prg. No.	Programm	Prg. Nr.
Split	1	Table B1	120
Split Sequential	3	Table B2	121
Parallel Diff.	4	Table B3	122
Parallel Net	5	Table C	123
Dual Timer	6	Two Stage Jumping	124
Speed	7	American Stage F	125
Speed Skiing	8	American Stage F / Time	126
Carving	9	Standard / Time 1	127
10-channel-Timer	10	Standard / Time 2	128
10-channel-Timer 1	101	Team Jumping 1	129
10-channel-Timer 2	102	Team Jumping 2	130
Show Jumping	11	Team Jumping 3	131
Table A1	111	Team Jumping 4	132
Table A2	112	Table A Time Delayed	133
Table AM3	113	Speed Skating	12
Table AM4	114	Cycling	14
Table AM5	115	Cycle-Road	141
Table AM6	116	Agility	15
Table AM7	117	Examine	151
Table AM8	118	TdC Test	16
Table AM9	119		

6.1 Split, Program 1

Net timing for competitions with any number of competitors started the race (mass start or individual start, e. g. alpine skiing, Nordic skiing, cycling individual time trial). One start channel, one finish channel and up to 8 intermediate time channels are available.

Split allows executing up to 256 heats.

You can set for the 2nd and following heats if the time is started from 0:00.00 or the total time of the previous heat.

Example: alpine or nordic

TdC 8001 is connected with the two-core connection wire to the Startgate. Via the speech connection the start can contact the TdC 8001 user. In the finish a photocell is used and connected with cable 001-10 to the TdC 8001.

The display board GAZ can show start number run time and rank for the audience.

Additional photocells can be connected for intermediate times.

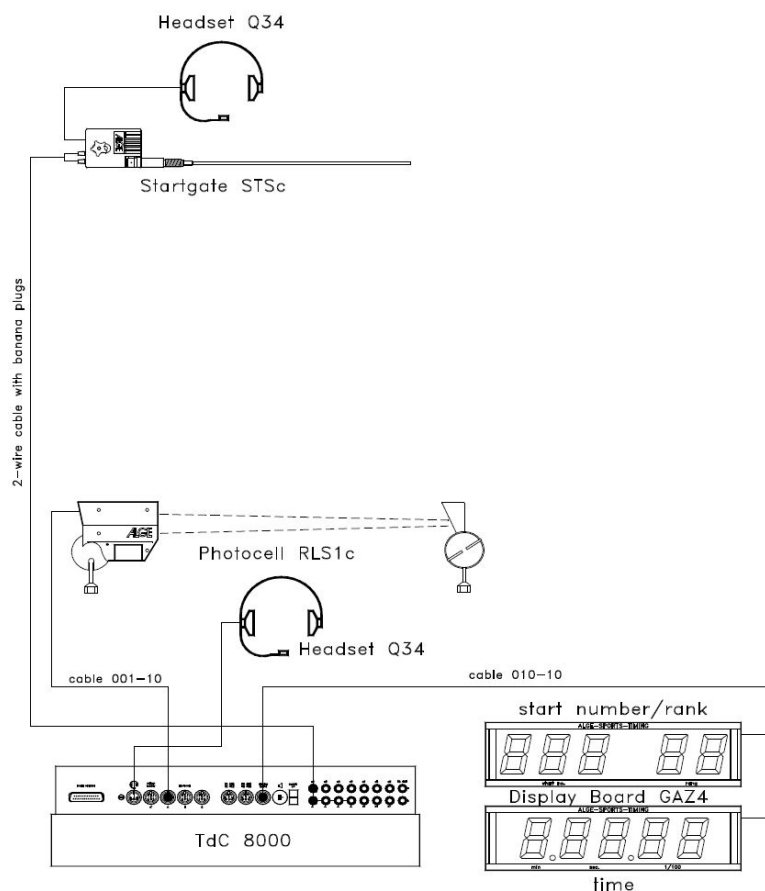

Activation procedure:

- Turn on TdC 8001 (switch g).
- Select program SPLIT with cursor keys, <ENTER>
- Clear memory for race that is used (e. g. <F1> race 1), <ENTER>
- Select race, <ENTER>
- Select precision, <ENTER>
- Select timing mode, <ENTER>
- Select start mode, <ENTER>
- Press <YES> for input of groups, otherwise <NO> and <ENTER>
- Enter last number of group when using groups
- Confirm every input with <ENTER>
- Press <ENTER> after input of start number of last group
- Synchronize TdC 8001 (possibly with other timing devices)
- <F1> to accept displayed time of day
 - The next full minute, channel c0 outputs a start impulse
 - TdC 8001 is ready for timing
- <F2> if display (5) shows incorrect time of day
 - Enter time with finish keypad (8) and confirm with <ENTER>
 - Start the clock with a start signal (<START> or channel c0)

Race procedure:

- Enter * and + on keypad (9), middle segment in display (1) is at the top
- Enter start number for start with start keypad (12), <ENTER>
- Display (1) must show correct start number (and group)
- Enter start number for finish with finish keypad (8), <ENTER>
- Display (6) must show the correct start number (and group)
- Start impulse for number 1 is effected
- Display (5) shows running time
- Display (1) automatically jumps to next start number

- Start impulse for number 2 is effected
- Display (1) automatically jumps to next start number
- Finish impulse of start number 1 is effected
- Display (5) shows run time of start number 1
- Start impulse for number 3 is effected
- Display (1) automatically jumps to next start number, <ENTER>
- Display (5) shows run time of start number 2
- Finish impulse of start number 2
- Display (5) zeigt the Run time von Start number 2
- etc.

Channel assignment

c0 = start channel	c5 = intermediate time
c1 = finish channel	c6 = intermediate time
c2 = intermediate time	c7 = intermediate time
c3 = intermediate time	c8 = intermediate time
c4 = intermediate time	c9 = intermediate time

Default main menu:

Menu 1:	delay time start	=	1.0 sec.
Menu 2:	delay time finish	=	0.3 sec.
Menu 3:	seconds mode	=	off
Menu 4:	display time 1	=	3 sec.
Menu 5:	display time 2	=	3 sec.
Menu 6:	display thousandth	=	off
Menu 7:	info display	=	finish
Menu 8:	running time	=	heat
Menu 9:	running tenth	=	off
Menu 10:	intermediate time rank	=	on
Menu 11:	finish rank	=	on
Menu 12:	start number automatic	=	off
Menu 13:	automatic time	=	00:00:00.00
Menu 14:	print start time	=	off
Menu 16:	printer linefeed	=	0
Menu 17:	RS232 baud rate	=	9600 baud
Menu 18:	RS232 run time	=	off
Menu 19:	d-board baud rate	=	2400 baud
Menu 20:	d-board channel 2	=	running
Menu 21:	beep	=	on
Menu 22:	handicap time	=	00:00:00.00
Menu 23:	groups	=	off
Menu 24:	change heat		
Menu 25:	change race		
Menu 26:	d-board test		
Menu 53:	bib-counting	=	manual
Menu 55:	LED-brightness	=	9
Menu 56:	delaytime to next StNo	=	3
Menu 59:	pulse from radio	=	alle Kanäle aus
Menu 60:	startnumber-info RS232	=	aus
Menu 61:	next syncimpulse		
Menu 62:	extern beep	=	alle Kanäle aus
Menu 63:	RS485 user	=	Wireless TN (WTN)
Menu 64:	last impulses validity	=	0,00 Sekunden

Printer: example for a printout

1st heat:

0001	ST	10:05:58.9903	start time
0001	FT	10:07:20.2343	finish time
	RT	1:21.24	run time





2nd heat:

0001	ST	10:07:01.4858	start time
0001	FT	10:08:22.3854	finish time
	RT	1:20.90	run time
	MT	1:21.24	memory time e.g. 1 st heat
	TT	2:42.14	total time

Display Board GAZ5:

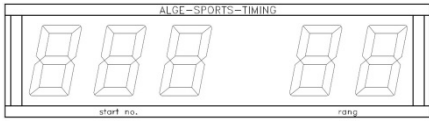
The net time and start number/rank can be displayed on every **ALGE** display board. Always the current number shown in display (6) is shown (on the display board the number is three-digit, the rank two-digit).

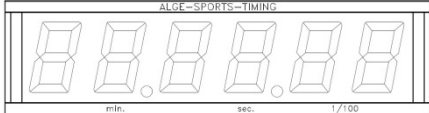
channel 2 can be activated in the main menu (see menu 20). When working with channel 2, only the stopped time is shown on the display board (no running time).

<p>Start number/ Rank</p>		 thumbwheel switch on 0	 toggle switch up
<p>Run time and Running time</p>		 thumbwheel auf 0	 toggle switch middle

RS232 interface: see chapter 8.2

6.2 Split-Sequential, Program 3

Net timing and lap timing for competitions with single or mass start with any number of competitors in the competition at the same time (e. g. relay at Nordic skiing). One start, one finish and up to eight intermediate time channels are available.

Always input the number of laps for split-sequential. When the last stop impulse is reached (last lap, finish crossing) the time for this competitor does not continue in the display. Every stop impulse except for the last is shown on the display and the scoreboard for as long as the display time 1 indicates.

256 heats can be executed. When starting a new heat, only the run times of the previous one are adopted.

You can set if the time starts with 0:00.00 or with the total time of the previous/all previous heats.

In split-sequential no groups can be entered.

Activation procedure:

- Turn on TdC 8001 (switch g)
- Enter program number 3 on finish keypad (8), <ENTER>
- Clear memory for race that is used, <ENTER>
- Select race
- Enter number of laps, <ENTER>
- Select precision, <ENTER>
- Select start mode, <ENTER>
- Synchronize device, select synchronization mode with <F1> (if correct display of time of day) or <F2> (if time of day must be synchronized)
- Start time of day (with impulse on channel 9 or <START>)

Race procedure with mass start and three laps:

- No setting possible on keypad (12) for mass starts, start display (1) shows "1"
- Input start number for finish (finish keypad (8), e. g. Stn^o. 1)
- <ENTER>
- Display (6) must show entered start number 1, display (5) must show time zero
- Start impulse for all competitors effected (mass start)
- Display (5) shows running time, display (6) shows start number 1 and 1 for 1st lap
- Display (1) now shows b1 (b = occupied start)
- Finish impulse for the first lap of start number 1 effected
- Time stops on display (5) and continues after the display time 1 set in menu 4. Display (6) still shows start number 1 but the lap counter increased to 2.
- etc.
- Finish impulse for second lap of start number 1 effected
- Time stops on display (5) and continues after the display time 1 set in menu 4. Display (6) still shows start number 1 but the lap counter increased to 3.
- etc.
- Finish impulse for third lap of start number 1 effected.
- Time stops on display (5). On display (6) start number 1 and lap number 3 are still shown.

Modify times:

A lap time cannot directly be corrected. The lap time is modified when the time of channel 0 or 1 or the run time is changed.

Channel assignment

c0 = start channel	c5 = intermediate time
c1 = lap/end time	c6 = intermediate time
c2 = intermediate time	c7 = intermediate time
c3 = intermediate time	c8 = intermediate time
c4 = intermediate time	c9 = intermediate time

Default main menu:

Menu 1:	delay time start	=	1.0 sec.
Menu 2:	delay time finish	=	0.3 sec.
Menu 3:	seconds mode	=	off
Menu 4:	display time 1	=	3 sec.
Menu 5:	display time 2	=	3 sec.
Menu 6:	display thousandth	=	off
Menu 7:	info display	=	finish
Menu 8:	running time	=	heat
Menu 9:	running tenth	=	off
Menu 10:	intermediate time rank	=	on
Menu 11:	run time rank	=	on
Menu 12:	start number automatic	=	off
Menu 13:	automatic time	=	00:00:00.00
Menu 14:	print start time	=	off
Menu 16:	printer linefeed	=	0
Menu 17:	RS232 baud rate	=	9600 baud
Menu 18:	RS232 run time	=	off
Menu 19:	d-board baud rate	=	2400 baud
Menu 20:	d-board channel 2	=	running
Menu 21:	beep	=	on
Menu 22:	handicap time	=	00:00:00.00
Menu 23:	groups	=	off
Menu 24:	change heat		
Menu 25:	change race		
Menu 26:	d-board test		
Menu 53:	bib-counting	=	manual
Menu 55:	LED-brightness	=	9
Menu 56:	delaytime to next StNo	=	3
Menu 59:	pulse from radio	=	alle Kanäle aus
Menu 60:	startnumber-info RS232	=	aus
Menu 61:	next syncimpulse		
Menu 62:	extern beep	=	alle Kanäle aus
Menu 63:	RS485 user	=	Wireless TN (WTN)

Printer: example for printout

1st heat:

0001	ST	10:00:00.0000	start time
0001	FT	10:10:20.2340	finish time
	RT	10:20.2	run time
1	SQ	10:20.2	lap time of 1 st heat
0001	ST	10:00:00.000	start time
	FT	10:20:39.334	finish time
	RT	20:39.3	run time
2	SQ	10:19.1	lap time of 2 nd heat

2nd heat:

0001	ST	14:00:00.0000	start time
0001	FT	14:11:20.5412	finish time
	RT	11:20.5	run time
1	SQ	11:20.5	lap time of 1 st heat
	MT	20:39.3	memory time 1 st heat
	TT	31:59.8	total time (1 st heat plus time 2 nd heat so far)
0001	ST	14:00:00.0000	start time
	FT	10:22:00.4016	finish time
	RT	22:00.4	run time
2	SQ	10:49.9	lap time 2 nd heat
	MT	20:39.3	memory time 1 st heat
	TT	42:39.7	total time (1 st heat plus 2 nd heat)

Display board GAZ5:

With one display board GAZ5 each can be shown:

Start number/rank, run time (or running time), lap time (sequential time)

channel 2 can be activater in main menu (see menu 20). When working with channel 2, only the stopped time is shown on the scoreboard (no running time).

start number/
rank

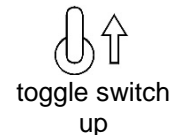
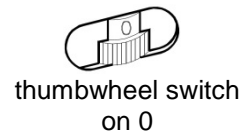
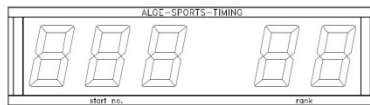

run time and
running time

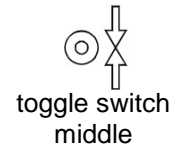
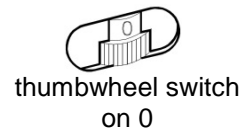

lap time

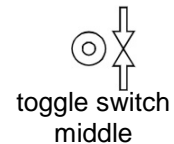
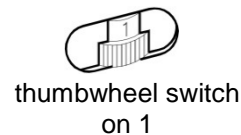

RS232 interface: see chapter 8.2

All times are issued similar to the split program. If settings in menu are "RS232 run time = on", run and lap time are issued.

6.3 Parallel Slalom

6.3.1 Parallel Diff. (parallel slalom with finish difference time), program 4

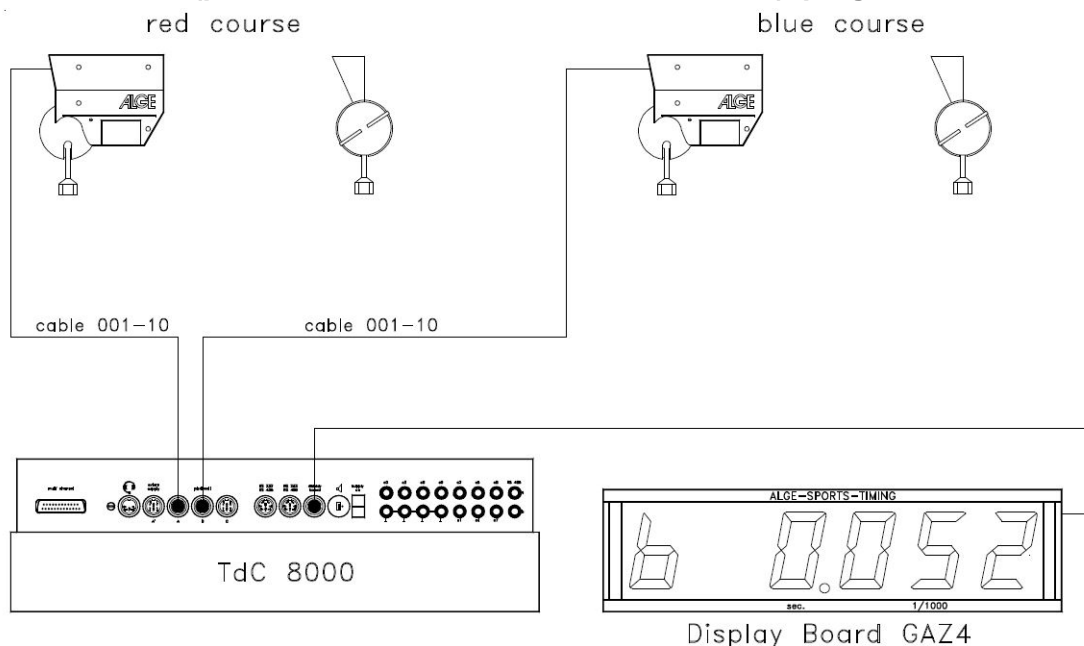

- Enter for every pair a heat number (automatic counting 1 – 9999)
- Two photocells are required for the finish, one for the blue and red course each
- The first photocell impulse triggers the timing; the second one stops the clock.
- Winner course and time margin of winner are shown (R = red, B = blue)
- No cabling from start to finish for timing is necessary
- Connect photocell red course to channel 1 (cable 001-10 to jack 19 or 20)
- Connect photocell blue course to channel 4 (cable 001-10 to jack 21)

Activation procedure:

- Turn on TdC 8001 (switch g)
- Select program parallel slalom difference (program 4) with cursor keys and <ENTER>
- Clear memory for race that is used and <ENTER>
- Select race and <ENTER>
- Synchronized TdC 8001 (possibly with other timing devices)
- <F1> to accept displayed time of day
 - At the next full minute a start impulse is issued via channel c0.
 - TdC 8001 is ready for timing.
- <F2> if display (5) shows incorrect time of day
 - Enter time with finish keypad (8) and confirm with <ENTER>
 - Start the clock with a start signal (<START> or channel c0)
 - TdC 8001 is ready for timing.

Race procedure:

- Enter * and + on keypad (9), middle segment on display (1) is on upper position
- Displays (1) and (6) show automatically heat number 1.
- For a different heat number, enter it with keypad (8) or (12) and confirm with <ENTER>
- Displays (1) and (6) must show correct heat number.
- Display (5) shows time 0.000
- Press <ALT> and <MENU> at the same time to enter the main menu.
- Press  once to show menu 28 penalty time
- Check penalty time:
 - If penalty time is correct press <ALT> and <MENU> at the same time for exit.
 - If penalty time is incorrect press <YES>:
 - Enter correct penalty time with finish keypad (8)

- Confirm with <ENTER>
- Exit main menu by pressing <ALT> and <MENU> at the same time
- TdC 8001 is not connected with the start and therefore the start is not timed.
- With first finish impulse display (5) shows running finish difference time and winner course.
- With second finish impulse display (5) shows finish difference time and winner course
- For preparing the TdC 8001 for the next race, press <ENTER>
- Displays (1) and (6) show next heat number
- Display (5) shows time 0.000
- etc.

Penalty time:

The penalty time is used as finish difference time if a competitor drops out. When no penalty time is required, enter 0.000 as penalty time.

When a competitor reaches the finish, the finish difference time starts. If the second competitor does not reach the finish before the penalty time is over, the penalty time is shown on display (5) and the scoreboard. The printer marks the penalty time with a "P". The penalty time is entered in the main menu (i) (see menu 28).

Clear times:

Pressing <CLEAR> of the start keypad (12) or finish keypad (8) clears the finish impulses. The finish impulses of the blue (c1) and red (c4) course are cleared if both have already a finish impulse.

Block times:

Every course can be blocked separately. Press <BLOCK> on start keypad (12) to print out the time of the blue course (c4) as invalid (time of day with ?). Press <BLOCK> of finish keypad (8) to print out the red course (c1) as invalid (time of day with ?). Pressing <ALT> and <BLOCK> at the same time the corresponding impulse is swallowed.

Channel assignment

c0 = start channel	c5 = intermediate time
c1 = lap/end time	c6 = intermediate time
c2 = intermediate time	c7 = intermediate time
c3 = intermediate time	c8 = intermediate time
c4 = intermediate time	c9 = intermediate time

Default main menu:

Menu 2	delay time finish	=	0.3 sec.
Menu 3:	seconds mode	=	off
Menu 4:	display time 1	=	3 sec.
Menu 9:	running tenth	=	off
Menu 12:	start number automatic	=	off
Menu 13:	automatic time	=	00:00:00.00
Menu 16:	printer linefeed	=	0
Menu 17:	RS232 baud rate	=	9600 baud
Menu 18:	RS232 run time	=	off
Menu 19:	d-board baud rate	=	2400 baud (fix)
Menu 20:	d-board channel 2	=	running
Menu 21:	beep	=	on
Menu 25:	change race	=	no function
Menu 26:	d-board test	=	off
Menu 27:	ID channel 4	=	b (blue)
Menu 28:	penalty time	=	off
Menu 53:	bib-counting	=	manual
Menu 55:	LED-brightness	=	9
Menu 59:	pulse from radio	=	alle Kanäle aus
Menu 62:	extern beep	=	alle Kanäle aus
Menu 63:	RS485 user	=	Wireless TN (WTN)

Display:

- In displays (1) and (6) the heat number of the pair is shown.
- Display (5) shows the winner course and finish difference time
- Info display (7) has no function for timing

Printer: example of printout

0001	r		1.231	Heat no 1: red course wins with 1.231 margin
0002	b		0.429	Heat no 2: blue course wins with 0.429 margin
P0003	b		1.500	Heat no 3: blue course wins (course penalty time)
?0003	C1	10:15:34.	2373	Heat no 3: invalid impulse
0004	r		0.217	Heat no 4: red course wins with 0.217 margin
c0004	r		0.217	Heat no 4 was cleared

Photocells for finish:

- The photocell for the red course is connected to the TdC 8001. For cables 001-10, 001-20 or 001-30 jack A (A') or A' (A) is used. For external supply of the photocell also a two core cable can be used. It is connected with banana plugs to channel c1 (h).
- The photocell for the blue course is connected to the TdC 8001. For cables 001-10, 001-20 or 001-30 the jack B (B) is used. For external supply of the photocell also a two core cable can be used. It is connected with banana plugs to channel c4 (h).

Display board GAZ5:

The finish difference time can be shown on an **ALGE** display board. The winner course is always displayed together with the difference time (r = red, b = blue).

In the main menu (see menu 27) can be set if the output for winner course is red (r) and blue (b) or right (r) and left (L).

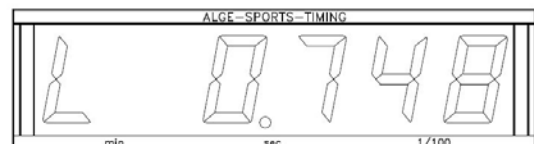
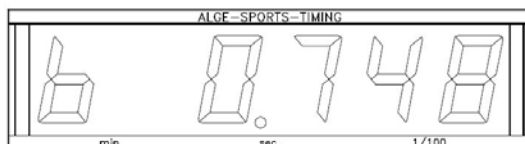
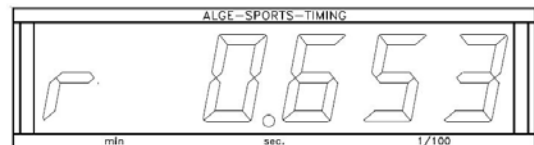
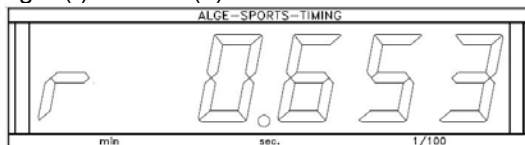

In the main menu (see menu 20) channel 2 can be activated. If working with channel 2, only the stopped time is shown on the display board (no running time).

Output format:

1 Startbit, 8 Databit, no Paritybit, 1 Stopbit

Transfer rate:

2,400 baud

Transfer protocol:

ASCII

NNNPxxxxxxxxx : Sz . ht (CR)	standing time before a competitor reaches the finish
NNNPxxxxxxxxbS : Sxxxx (CR)	running finish difference time (win blue course, no 1/10)
NNNPxxxxxxxx§S : Sxxxx (CR)	running finish difference time (win red course, no 1/10)
NNNPxxxxxxxx\$S : Sxxxx (CR)	running finish difference time (win left course, no 1/10)
NNNPxxxxxxxxbS : Szxxxx (CR)	running finish difference time (win blue course, with 1/10)
NNNPxxxxxxxx§S : Szxxxx (CR)	running finish difference time (win red course, with 1/10)
NNNPxxxxxxxx\$S : Szxxxx (CR)	running finish difference time (win left course, with 1/10)
NNNPxxxxxxxxbS : Sz ht (CR)	finish difference time (win blue course)
NNNPxxxxxxxx§S : Sz ht (CR)	finish difference time (win red course)
NNNPxxxxxxxx\$S : Sz ht (CR)	finish difference time (win left course)

x..... blank

NNN..... heat number

P..... identification for parallel slalom

§..... red (right) course (special character 0A hex. for r(= red course), 12. character)

b..... blue course (12. character)

\$..... left course (special character 0C hex. for L (= left course), 12. character)

S seconds (on the decade of the seconds a zero is not shown)
 z 1/10 seconds
 h 1/100 seconds
 t 1/1000 seconds
 (CR) Carriage Return

Output via RS232c interface

Output format: 1 startbit, 8 databit, no paritybit, 1 stopbit
Transmission speed: 9,600 baud preferred settings (adjustable: 2400, 4800)
Transmission protocol: ASCII

xNNNNxC4xxHH:MM:SS.zhtqxxxxxxxx(CR)
 xNNNNxC1xxHH:MM:SS.zhtqxxxxxxxx(CR)
 ?NNNNxC4xxHH:MM:SS.zhtqxxxxxxxx(CR)
 ?NNNNxC1xxHH:MM:SS.zhtqxxxxxxxx(CR)
 cNNNNxC4xxHH:MM:SS.zhtqxxxxxxxx(CR)
 cNNNNxC1xxHH:MM:SS.zhtqxxxxxxxx(CR)

The following times are only transmitted with the following setting in main menu:

Menu 18: RS232 run time = ON

xNNNNxbxxxHH:MM:SS.zht(CR)	winner blue course (selection menu 27)
xNNNNxlxxxHH:MM:SS.zht(CR)	winner left course (selection menu 27)
xNNNNxrxxxHH:MM:SS.zht(CR)	winner red or right course
cNNNNxbxxxHH:MM:SS.zht(CR)	cleared with <CLEAR>
cNNNNxlxxxHH:MM:SS.zht(CR)	cleared with <CLEAR>
cNNNNxrxxxHH:MM:SS.zht(CR)	cleared with <CLEAR>

x blank
 NNNN heat number
 C1 channel 1 (red course)
 C1M channel 1 (red course finish impulse triggered with key <STOP>)
 C4 channel 4 (blue course)
 C0M channel 0 (blue course, finish impulse triggered with key <START>)
 r red/right course
 b blue course
 l left course
 HH:MM:SS.zht time accurate to 1/1000 seconds
 HH:MM:SS.zhtq time accurate to 1/10,000 seconds
 ? invalid time
 c time cleared with <CLEAR>
 (CR) Carriage Return

6.3.2 Parallel Slalom Net, Program 5

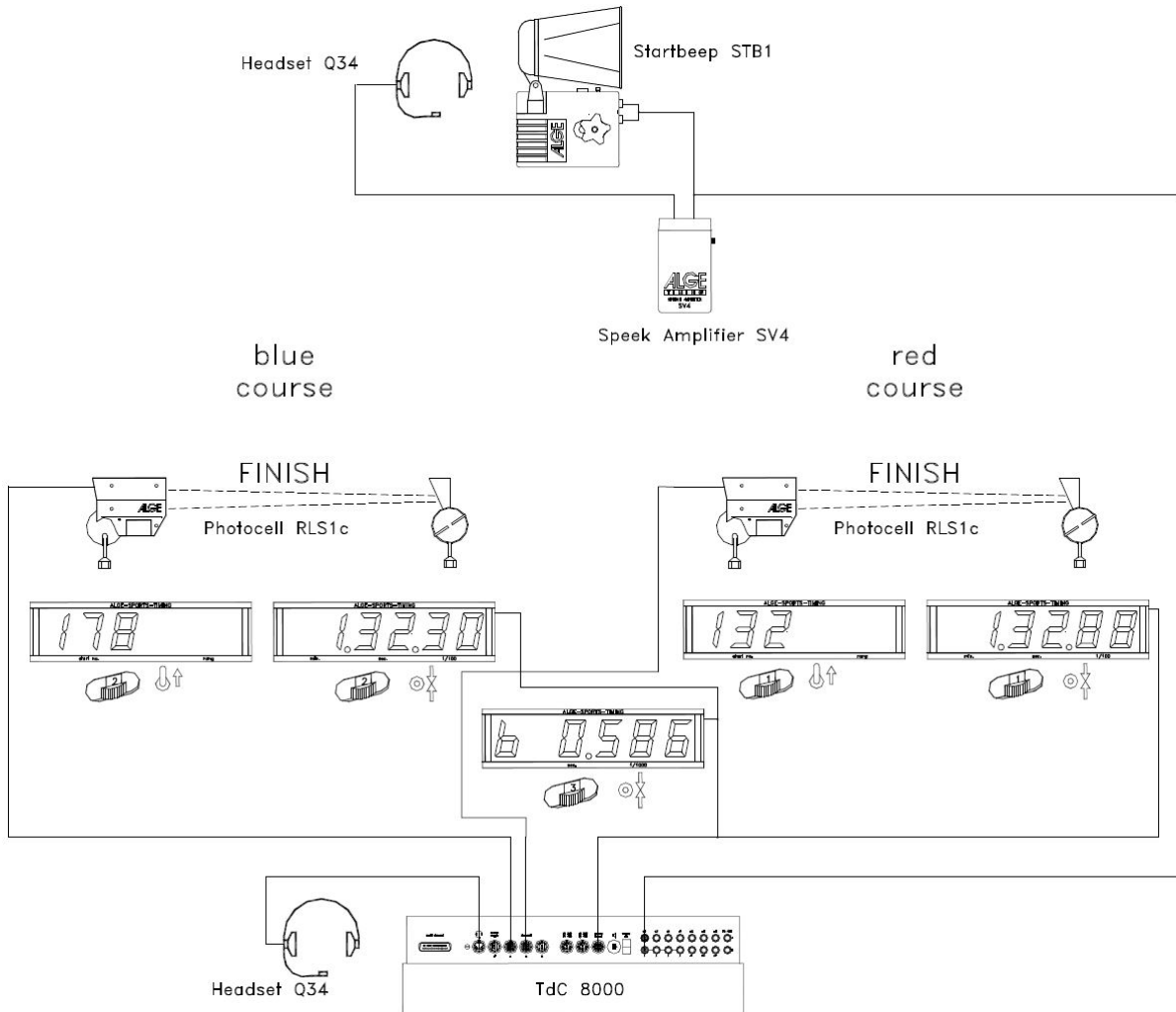

Parallel Slalom with timing of run times (net time) and finish difference time. The timing can be executed for both heats with heat total time and total finish difference time.

Activation procedure:

- Turn on TdC 8001 (switch g)
- Select program PARALLEL NET (program 5) with **F1** and **F2** <ENTER>
- Clear storage for races that is used, <ENTER>
- Select race, <ENTER>
- Select precision, <ENTER>
- Synchronize TdC 8001 (possibly with other timing devices)
- Press <F1> to confirm display time of day
 - The next full minute a start impulse is sent via channel c0.
 - TdC 8001 is ready for timing.
- Press <F2> if display (5) shows wrong time of day.
 - Enter time with finish keypad (8) and confirm with <ENTER>.
 - Start clock with a start signal (key <START> or channel c0)

Race procedure 1st heat:

- Enter start number for blue (left) course with keypad (12), <ENTER>
- Display (1) must show start number of blue (left) course.
- Enter start number for red (right) course with keypad (8), <ENTER>
- Display (6) must show start number of red (right) course.
- Info display (5) must show start number of blue (left) and red (right) course as well as the appropriate time 0:00.00

- Start impulse for both competitors is effected (channel c0 or c3); key <START> does not work
- Displays (1) and (6) show start number and "b" (b = occupied)
- Info display (7) must show start number of blue (left) and red (right) course as well as appropriate running time.
- Finish impulse for number 1 effected
- Finish impulse for number 2 effected
- Info display (7) must show start number of blue (left) and red (right) course as well as the appropriate run time.
- Info display (7) shows difference time in addition to winner time.
- The start numbers for the next competitor pair can be entered identically.

Race procedure 2nd heat:

Change heat:

- All competitors must have finished 1st heat.
- Press <ALT> and <MENU> at the same time.
- Enter the number 23 with finish keypad (8)
- Info display (7) now shows "change heat", press <YES>
- Press <F2> so that the next heat is selected. Confirm with <ENTER>.

In 2nd heat the same two start numbers compete but the courses are switched. The start number using the blue course in 1st heat cannot be entered for the blue course for 2nd heat anymore. Same applies for the red course. When entering the first start number in 2nd heat, automatically the correct associated startnumber appears. The first pair is automatically preset by the TdC 8001. In menu 8 always "running time = heat" has to be set.

- Enter start number for blue (left) course with keypad (12), <ENTER>
- Start number for red (right) course appears automatically
- Display (1) must show start number of blue (left) course
- Display (6) must show start number of red (right) course
- Info display (7) must show start number of blue (left) and red (right) course as well as the associated time 0:00.00 (it can also be switched to total time)
- For the winner of 1st heat the finish difference time of 1st heat is shown
- Start impulse for both competitors is effected (channel c0 or c3)
- Displays (1) and (6) must show start numbers and "b" (b = occupied)
- Info display (7) must show start number of blue (left) and red (right) course as well as appropriate running time
- Finish impulse for number 1 effected
- Finish impulse for number 2 effected
- Info display (7) must show start number of blue (left) and red (right) course as well as the appropriate run time
- Info display (7) shows heat difference time next to winner time
- After end of display time, net total time as well as total difference time is shown for both competitors
- Start numbers for next pair of competitors can be entered identically

Further heats:

Every time a competitor competes with a new opponent, there is a new round. I. e. in the first round for example start number 1 competes 8 as well as start number 5 competes 4. After the second heat the competitor with the best total time reaches the next round.

Before a new round is started, the user must communicate this to the TdC 8001 by opening menu 24. Then "change heat" and "next" (<F2>), confirm with <ENTER>.

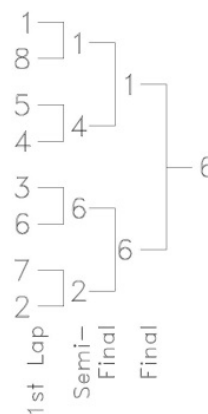

Functions of keys	BLUE (left) Keypad (9) or (14)	RED (right) Keypad (15) or (14)
Clear finish time	CLEAR	CLEAR
Restore finish time	ALT + CLEAR	ALT + CLEAR
invalid finish times	BLOCK	BLOCK
Suppress finish time	ALT + BLOCK	ALT + BLOCK
No function	INPUT	INPUT
No function	MENU + INPUT	MENU + INPUT
No function	F1	F1
No function	F2	F2
No function	F3	F3
Switch between finish and start time	F4	F4
No function	CLASS.	CLASS.

Penalty time:

The penalty time is applied as finish difference time when a competitor drops out of the race. In case no penalty time is used, 0.000 has to be entered as penalty time.

When a competitor reaches the finish, the finish difference time starts. When the second competitor does not reach the finish before the end of penalty time, the penalty time is shown on display (5) and scoreboard. The printer marks the penalty time with "P". The penalty time is entered in the main menu.

Clear finish times:

<CLEAR> applies to each corresponding course that is assigned to the keypad:

<CLEAR> of keypad (12) - blue (left) course

<CLEAR> of keypad (8) - red (right) course

<CLEAR> clears the last impulse of the corresponding course i. e. when <CLEAR> is pressed after the start the time is reset to zero.

<CLEAR> is pressed when the competitor has finished. The running time appears once more. Pressing <CLEAR> again clears the start time.

With shortcut <ALT> and <CLEAR> the last deleted time can be restored.

In case a penalty time is set (menu 28) the time with the calculated penalty time is automatically shown after the finish time is cleared (if the other course already has a finish time).

Block finish times:

The finish time of each course can separately be blocked. If <BLOCK> of keypad (12) is pressed, the finish time of the blue (left) course (c4) is printed invalid (time of day with ?). If <BLOCK> is pressed on the finish keypad (8), the time of the red (right) course (c1) is printed invalid (time of day with ?). Pressing <ALT> and <BLOCK> at the same time swallows the corresponding impulse.

Enter times: <INPUT> has no function

Ranking: <CLASS> has no function

Course identification:

The courses can be identified with r (= red) and b (= blue) or r (= right) and L (= left). The selection for the identification if the course is marked with b or L is executed in the main menu (menu 27: Identification channel 4)

Photocells for finish:

- Red (right) course is connected to channel 1 (cable 001-10 in jack A')
- Blue (left) course is connected to channel 4 (cable 001-10 in jack A)

Photocells for 1st intermediate time:

- Red course on channel 2
- Blue course on channel 5

Photocells for 2nd intermediate time:

- Red course on channel 6
- Blue course on channel 7

Photocells for 3rd intermediate time:

- Red course on channel 8
- Blue course on channel 9

Channel assignment

c0 = start channel (= c3)	c5 = intermediate time 1 blue
c1 = finish channel red	c6 = intermediate time 2 red
c2 = intermediate time 1 red	c7 = intermediate time 2 blue
c3 = start channel (= c0)	c8 = intermediate time 3 red
c4 = finish channel blue	c9 = intermediate time 3 blue

Preset main menu:

Menu 1	delay time start	=	1.0 sec.
Menu 2	delay time finish	=	0.3 sec.
Menu 3:	seconds mode	=	off
Menu 4:	display time 1	=	3 sec.
Menu 5:	display time 2	=	3 sec.
Menu 8:	running time	=	run
Menu 9:	running tenth	=	off
Menu 14:	print start time	=	off
Menu 16:	print linefeed	=	0
Menu 17:	RS232 baud rate	=	9600 baud
Menu 18:	RS232 run time	=	off
Menu 19:	d-board baud rate	=	2400 baud
Menu 20:	d-board channel 2	=	running
Menu 21:	beep	=	on
Menu 24:	change heat		
Menu 25:	change race		
Menu 26:	d-board test		
Menu 27:	ID channel 4	=	b (blue)
Menu 28:	penalty time	=	1.500 sec.
Menu 53:	bib-counting	=	manual
Menu 55:	LED-brightness	=	9
Menu 59:	pulse from radio	=	alle Kanäle aus
Menu 60:	startnumber-info RS232	=	aus
Menu 62:	extern beep	=	alle Kanäle aus
Menu 63:	RS485 user	=	Wireless TN (WTN)

Display (1):

The start number of the competitor of the blue (left) course is shown. Furthermore this display shows the type of start number continuation (segment top – automatically next, segment bottom - automatically previous free) and the status of the starter (no display for not started, “b” for started, “L” for run time and “T” for total time (2nd heat)).

Display (6):

The start number of the competitor of the red (right) course is shown. Furthermore this display shows the status of the starter (no display for not started, “b” for started, “L” for run time and “T” for total time (2nd heat)).

Info display (7):

In the info display the current start numbers with the appropriate times are shown. After passing the finish also the time difference to the winner is shown.

0001 b	0:00.000
0002 r	0:00.000

display before start for 1st heat:
StNo., course (b = blue, r = red), time

0001 b	0:03
0002 r	0:03

display after start for 1st heat:
StNo., course (b = blue, r = red), running time

0001 b RT 0:44.206	display after finish arrival (1 st heat): st. no., course, runtime, winner lead
0002 r RT 0:44.106 -0.046	
0002 b 0:00.000-0.046	display before start for 2 nd heat: st. no., course, runtime, heat lead
0001 r 0:00.000	
0002 b RT 0:44.298 -0.025	display after finish (2 nd heat): st. no., course, runtime, heat time, heat lead
0001 r RT 0:44.323	
0002 b TT 1:28.458 -0.071	display after finish (2 nd heat): st. no., course, total time, total lead
0001 r TT 1:28.529	

Switch between runtime and total time with <F4> when the competitors have reached the finish in the 2nd heat. The total time for the 2nd heat can also be shown directly (menu 8 HEAT or TOTAL).

Printer: Example for printout
1st heat

0002 r ST 10:00:00.1213	start time red course, st no 2
FT 10:00:44.2813	finish time red course, st no 2
RT 0:44.160	run time red course, st no 2
0001 b ST 10:00:00.1213	start time blue course, st no 1
FT 10:00:44.3274	finish time blue course, st no 1
RT 0:44.206	run time blue course, st no 1
0002 r DTH -0.046	lead of red course in 1 st heat (st no 2)

2nd heat

0002 b ST 10:30:10.0014	start time blue course, st no 2
FT 10:30:54.2992	finish time blue course, st no 2
RT 0:44.298	run time blue course, st no 2
MT 0:44.160	memory time blue course, st no 2
TT 1:28.458	total time blue course, st no 2
0001 r ST 10:30:10.0014	start time red course, st no 1
FT 10:30:54.3345	finish time red course, st no 1
RT 0:44.323	run time red course, st no 1
MT 0:44.206	memory time red course, st no 1
TT 1:28.529	total time red course, st no 1
0002 b DTH -0.025	lead of blue course in 2 nd heat (st no 2)
0002 b DTT -0.071	total lead of st no 2 from both heats

Display Board GAZ finish difference time (run and total):

On a 6-digit Auf ALGE display board the 1st digit shows a b (= blue or L = left). Afterwards the time in seconds and 1/1000 seconds is displayed. Set the thumbwheel switch of the display on 0 and the toggle switch in middle position. The course identification b and r or L and r can be set in menu 27.

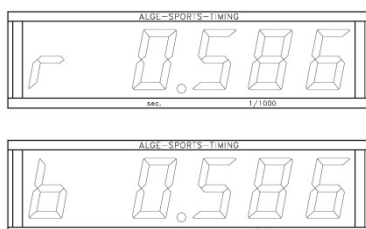

menu 27; ID channel 4 = b

red course



blue course

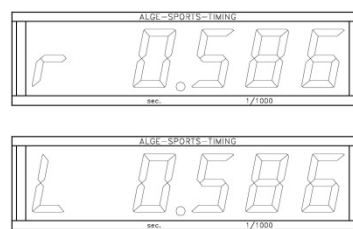

menu 27: ID channel 4 = L

red course



left course

Run time/total time:

For every course a separate display board is required. With the standard **ALGE** display board the time is shown in minutes, seconds and 1/100 seconds.

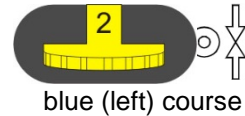
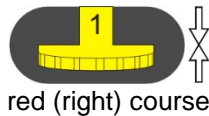
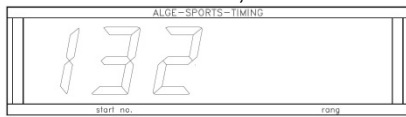

Start number:

For every course a separate display board is required. The start numbers are only shown with 3 digits.

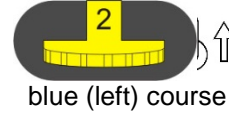
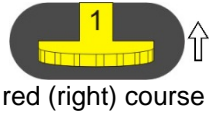

RS232c Interface

Output format

1 Startbit, 8 Databit, no Paritybit, 1 Stopbit

Transfer rate:

9,600 baud default setting (adjustable: 2400, 4800, 9600)

Transfer protocol:

ASCII

xNNNNiCCxxHH:MM:SS.zhtqx##(CR)..... Parallel slalom, intermediate time, finish time
 xNNNNiRTxxHH:MM:SS.zhtqx##(CR)..... Parallel slalom, run time
 xNNNNiDTRxxHH:MM:SS.zhtxx##(CR)..... Parallel slalom, run difference time
 xNNNNiTxxHH:MM:SS.zhtqx##(CR)..... Parallel slalom, total time
 xNNNNiDTTxxHH:MM:SS.zhtxx##(CR)..... Parallel slalom, total difference time
 pNNNNiCCxxHH:MM:SS.zhtqx##(CR)..... Parallel slalom, finish time calculated from penalty time
 pNNNNiRTxxHH:MM:SS.zhtqx##(CR)..... Parallel slalom, run time calculated from penalty time
 pNNNNiTxxHH:MM:SS.zhtqx##(CR)..... Parallel slalom, total time calculated from penalty time

x.....blank

NNNNstart number (four-digit)

i.....r (= red/right), b (= blue) or L (= left) course parallel slalom

CC.....timing channel

RTrun time

DTRDifference Time Run

DTTDifference Time Total

HH:MM:SS.zht.....time in hours, minutes, seconds and 1/1000 seconds

HH:MM:SS.zhtq.....time in hours, minutes, seconds and 1/10,000 seconds

##.....consecutive numbers at each heat

(CR)Carriage Return

The following figures can be in 1st position:

?.....time without valid start number

c.....times cleared (with CLEAR key)

p.....time calculated from penalty time at parallel slalom (penalty time)

RS485 interface: no function at current TdC 8001

6.4 Dual Timer, Program 6

Net timing with intermediate times on two courses with one competitor each on the course. The start can be effected at the same time for both courses or separately. The evaluation can be carried out for each course separately or jointly. Two heats are possible.

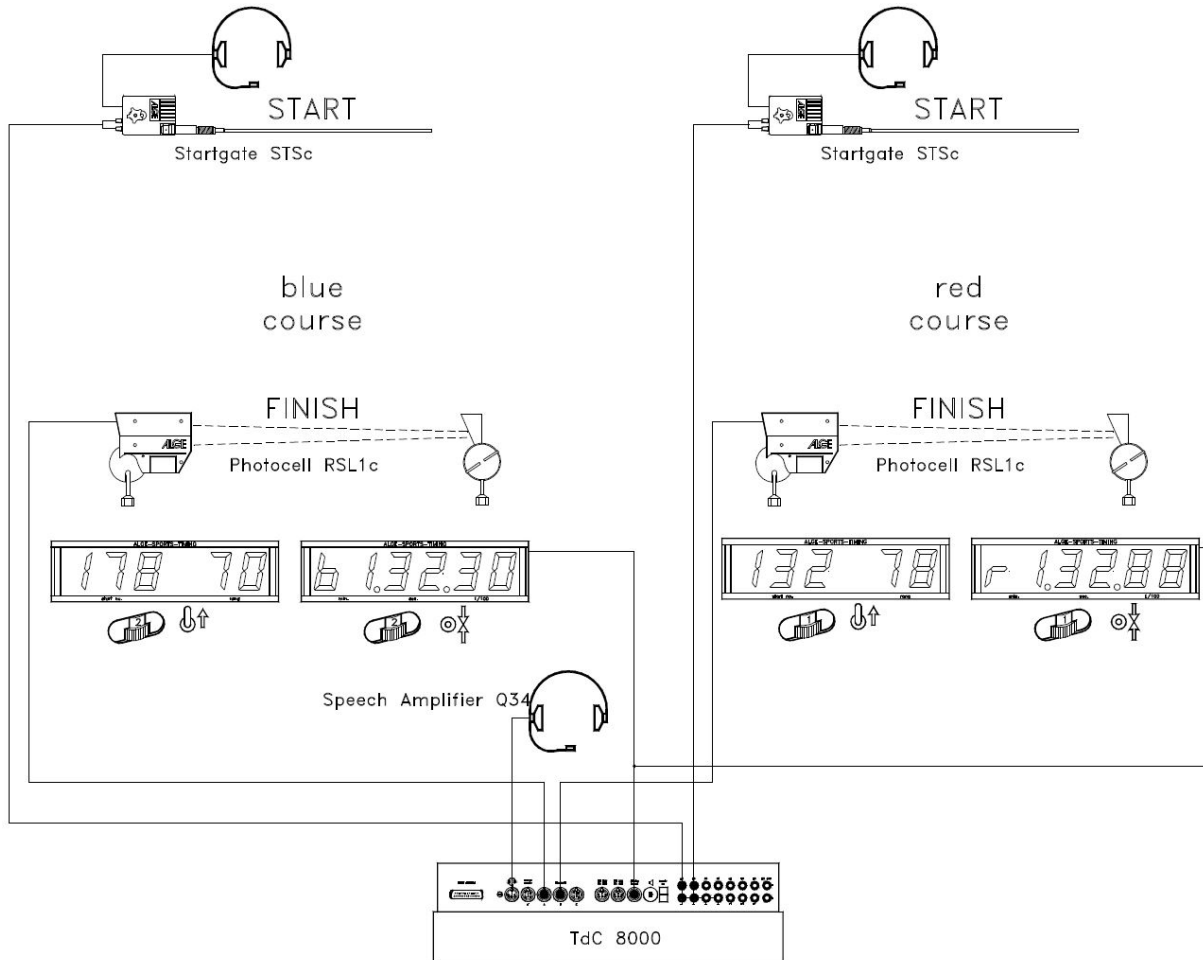

Activation procedure:

- Turn on TdC 8001 (switch g)
- select program DUAL TIMER (prog.no. 6) with \uparrow and \downarrow , <ENTER>
- clear storage for used race, <ENTER>
- select race, <ENTER>
- select precision, <ENTER>
- <YES>, if groups are to be entered, otherwise <NO> and <ENTER>.
 - always input last number of group
 - confirm every input with <ENTER>
 - after the entering start number of last group, press <ENTER>
- synchronize TdC 8001 (possibly with other ALGE timing devices)
 - press <F1> to confirm displayed day time
 - At next full minute a start impulse is output via channel c0.
 - TdC 8001 is ready for timing.
 - press <F2> if display (5) shows wrong time of day
 - enter time with finish keypad (8) and confirm with <ENTER>
 - start clock with start signal (<START> or channel c0)

Race procedure in 1st heat:

- enter start number for blue (left) course with keypad (12)
- <ENTER>

- display (1) must show start number (and group) of blue (left) course.
- enter start number for red (right) course with keypad (8)
- <ENTER>
- display (6) must show start number (and group) of red (right) course
- info display (7) must show the start number of blue (left) and red (right) course as well as appropriate time
- in main menu (<ALT> and <MENU>) can be set if the start takes place for both courses at the same time or separately (menu 29: start channel 28)
- start impuls for number 1 executed
- start impuls for number 2 executed
- info display (7) must show start number of blue (left) and red (right) course as well as the appropriate run time.
- The start numbers for the next competitor pair can be entered as before

Race procedure in 2nd heat:

change heat:

- all competitors must have finished the 1st heat
- press <ALT> and <MENU> at the same time
- enter number 23 with finish keypad (8)
- info display (7) now shows “change heat”
- press <YES>
- press <F2> to select next heat
- Confirm with <ENTER>, heat is changed

The pairs of the 2nd heat do not have to be the same as before, but every competitor has to change course. Start numbers that used blue course in 1st heat cannot be entered for blue course in 2nd heat. The same applies for red course.

- enter start number for blue (left) course with keypad (12)
- <ENTER>
- display (1) must show start number of blue (left) course
- enter start number for red (right) course with keypad (8)
- <ENTER>
- display (6) must show start number of red (right) course
- info display (7) must show start numbers of blue (left) and red (right) course as well as corresponding 0:00.00 (can also be changed to total time)
- start impulse for both competitors carried out separately or at the same time (setting menu 29)
- displays (1) and (6) must show start number and “b” (b = occupied)
- info display (7) must show start numbers of blue (left) and red (right) course as well as corresponding running time
- finish impulse for number 1 effected
- finish impulse for number 2 effected
- info display (7) must show start number of blue (left) and red (right) course as well as corresponding run time
- with end of display time the total net time of both competitors is automatically displayed
- start numbers for the next couple of competitors can be entered

Clear finish times:

By pressing <CLEAR> of keypad (12) the finish impulses of the blue (left) course can be cleared. If <ALT> and <CLEAR> are pressed at the same time, the previously cleared finish time is used once again as current finish time.

The same can be done for the red (right) course on keypad (8).

Block finish times:

The finish time of each course can separately be blocked.

Press <BLOCK> of keypad (12) to print finish time of blue (left) course (c4) as invalid (time of day with ?).

Press <BLOCK> of keypad (8) to print time of red (right) course (c1) as invalid (time of day with ?).

Pressing <ALT> and <BLOCK> at the same time results in the impulse being swallowed.

Modify times:

In Dual Timer the times can be copied from one start number to another, invalid times can be made valid or times can be entered manually. Use <INPUT> of keypad (12) to change times of the blue course, the one of keypad (8) for changing times of the red course.

- Change finish time of corresponding course with <INPUT>
- Change start time of corresponding course with <ALT> and <INPUT>
- Change run and intermediate times of corresponding course with <MENU> and <INPUT>

Ranking:

A ranking can be issued for both or for each individual course.

Rank calculation:

The rank calculation can be carried out for both courses or for each of them separately. Settings for rank calculation in main menu (menu 30: rank calculation).

Start channel:

The start can take place for both courses at the same time or for each one of them separately. Settings for start procedure in main menu (menu 29: start channel). If the joint start channel is used, the time for both courses is started no matter if channel c0 or channel c3 was triggered.

Course identification:

The courses can be marked with r (red) and b (blue) or r (right) and l (left). Selection for marking in main menu (menu 27: channel ID 4).

Channel assignment

c0 = start channel red (right)	c5 = intermediate time 1 blue (left)
c1 = finish channel blue (left)	c6 = intermediate time 2 red (right)
c2 = intermediate time 1 red (right)	c7 = intermediate time 2 blue (left)
c3 = start channel blue (left)	c8 = intermediate time 3 red (right)
c4 = finish channel blue (left)	c9 = intermediate time 3 blue (left)

Default main menu:

Menu 1	delay time start	=	1.0 sec.
Menu 2	delay time finish	=	0.3 sec.
Menu 3:	seconds mode	=	off
Menu 4:	display time 1	=	3 sec.
Menu 5:	display time 2	=	3 sec.
Menu 8:	running time	=	heat
Menu 9:	running tenth	=	off
Menu 10:	intermediate time rank	=	on
Menu 11:	run time rank	=	on
Menu 14:	print start time	=	off
Menu 16:	paperfeed	=	0
Menu 17:	RS232 baud rate	=	9600 baud
Menu 18:	RS232 run time	=	off
Menu 19:	d-board baud rate	=	2400 baud
Menu 20:	d-board channel 2	=	running
Menu 21:	beep	=	on
Menu 23:	groups	=	off
Menu 24:	change heat		
Menu 25:	change race		
Menu 26:	d-board test		
Menu 27:	ID channel 4	=	b (blue)
Menu 29:	start channel	=	separate
Menu 30:	rank calculation	=	separate
Menu 55:	LED-brightness	=	9
Menu 59:	pulse from radio	=	alle Kanäle aus
Menu 62:	extern beep	=	alle Kanäle aus

Printer: example of printout

0001	b	ST	10:05:58.9901	start time blue course
		FT	10:07:20.2342	finish time blue course
		RT	1:21.24	run time blue course
0002	r	ST	10:07:01.4855	start time red course
		FT	10:08:22.3856	finish time red course
		RT	1:20.90	run time red course

0001	l	ST	10:05:58.9907	start time left course
		FT	10:07:20.2347	finish time left course
		RT	1:21.24	run time left course

Display Board (D-LINE and GAZ)

Net time and start number/rank can be shown on a **ALGE** display board. Always the current number of display (6) is shown (on display board this number is only 3-digit, rank only 2-digit).

For each course a separate display board is required. For the red (right) course the code switch must be set to 1, for the blue (left) course to 2. channel 2 can be activated in main menu (see menu 20). If working with channel 2 only the stopped time is shown on the display board (no running time).

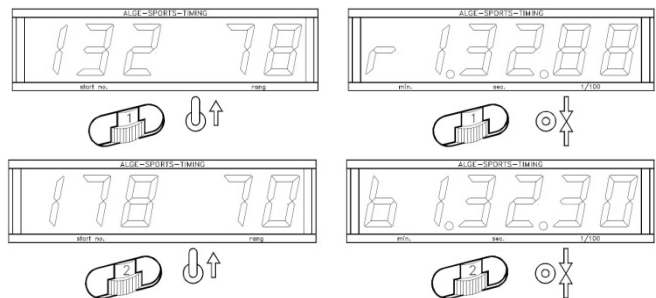

RS232 Interface: see chapter 8.2

6.5 Speed, Program 7

With this program the speed can be measured on a defined measuring distance (two photocells or other impulse devices)

measurement: adjustable in km/h, m/s or mph
 measuring distance: adjustable from 1 to 9999 m
 minimum speed: adjustable from 1 to 9999 km/h, m/s or mph
 maximum speed: adjustable from 1 to 9999 km/h, m/s or mph
 channels: channel c0 and c1 (passage possible from both directions)

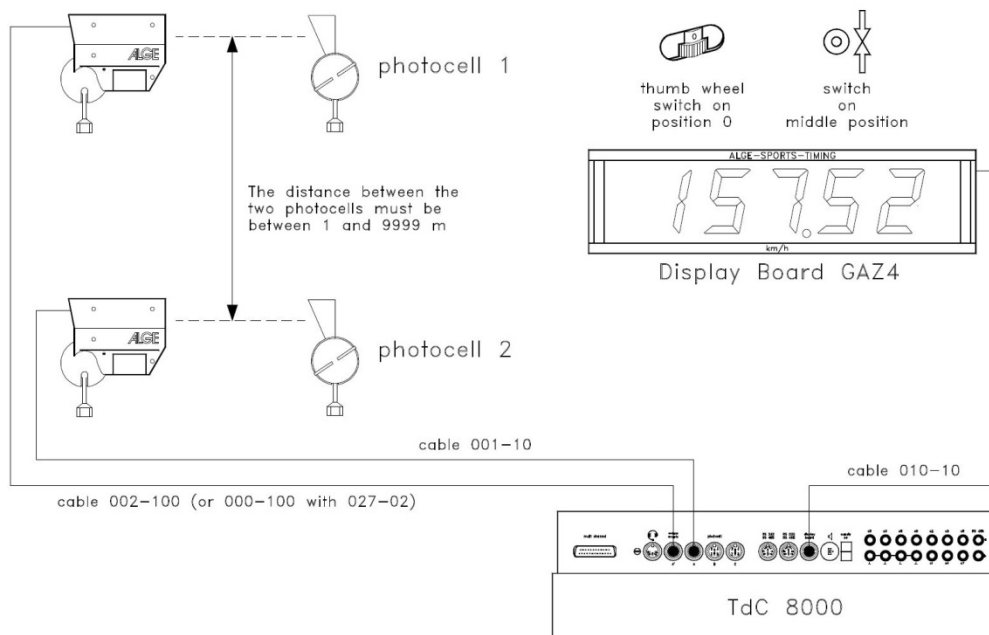

Activation procedure:

- turn-on TdC 8001 (switch g).
- select program 7 „speed“ cursor keys and <ENTER>
- clear memory for used race and <ENTER>
- select race and <ENTER>
- press <YES> for entering groups, otherwise <NO> and <ENTER>
 - when entering groups always enter last number of a group
 - confirm every input with <ENTER>
 - after start number of last group press <ENTER>
- synchronize TdC 8001 (possibly with other ALGE timing devices)
 - press <F1> for confirming displayed time of day
 - with next full minute start impulse is send via channel c0
 - TdC 8001 is ready for timing
- press <F2> if display (5) shows wrong time of day
 - enter time with keypad (8), confirm with <ENTER>
 - start clock with start signal (<START> or channel c0)

Race procedure:

- enter * and + on keypad (9), middle segment of display (1) is at the top
- press <MENU> and <ALT> at the same time
- set measuring distance in menu 32
- select unit in menu 33
- set minimum speed in menu 34
- set maximum speed in menu 35
- set if start number automatic is to be used in menu 4 (display time 1)
- select START or FINISH in menu 12 (start number automatic) if the measured value is only to be displayed for a certain time (display time 1)
- enter start number with start keypad (12) or finish keypad (8) and <ENTER>

- display (1) and display (6) must show correct start number (and group)
- display (5) shows 000.00 as speed
- first impulse of channel c0 arrives
- display (1) shows next to start number "L" as indication that the competitor passed the first photocell (channel c0)
- display (5) shows rank and speed
- Using start number automatic, display (2) and (8) switch after display time 1 to next number

Channel assignment

c0 = speed measuring channel	c5 = no function
c1 = speed measuring channel	c6 = no function
c2 = no function	c7 = no function
c3 = no function	c8 = no function
c4 = no function	c9 = no function

Default main menu:

Menu 1	delay time start	=	1.0 sec.
Menu 2	delay time finish	=	0.3 sec.
Menu 4:	display time 1	=	3 sec.
Menu 11:	run time rank	=	on
Menu 16:	printer linefeed	=	0
Menu 17:	RS232 baud rate	=	9600 baud
Menu 18:	RS232 run time	=	off
Menu 19:	d-board baud rate	=	2400 baud
Menu 21:	beep	=	on
Menu 23:	groups	=	off
Menu 25:	change race		
Menu 26:	d-board test		
Menu 31:	print times	=	off
Menu 32:	distance	=	100 m
Menu 33:	measuring unit	=	km/h
Menu 34:	min. speed	=	10 km/h
Menu 35:	max. speed	=	200 km/h
Menu 53:	bib-counting	=	manual
Menu 55:	LED-brightness	=	9
Menu 59:	pulse from radio	=	alle Kanäle aus
Menu 62:	extern beep	=	alle Kanäle aus
Menu 63:	RS485 user	=	Wireless TN (WTN)

Measuring distance:

The distance between both photocells (or other impulse transmitters) can be entered between 1 and 9999. The measuring distances is always entered in meters irrespective of the measuring unit. The measuring distance is set in menu 32.

Measuring unit:

Selection between the following units is possible:

- km/h kilometers per hour
- m/s meters per second
- mph miles per hour

The measuring unit is set in menu 33. When the unit is changed the minimum and maximum speed is automatically converted into the new unit.

Minimum and maximum speed:

The minimum and maximum speed can be set. In case a speed is measured that falls below the minimum speed or exceeds the maximum speed it is not accepted. The minimum speed is set in menu 34 and the maximum speed in menu 35. In every menu values of 1 to 9999 are possible; the unit corresponds to the one set in menu 33.

e. g.: min. speed = 60 km/h, max. speed = 120 km/h

Only speeds in the ranke of 60 to 120 km/h are shown

Print times:

In addition to the speeds the times can be printed. If in menu 31 "print times = ON" is selected, start, finish, run times and speed is issued.

Attention: Internally the time is measured and calculated with a precision of 1/10,000 genau gemessen and gerechnet. The printer only prints with a precision of 1/1,000.

Automatic speed measurement:

If in menu 12 "StNo Automatic" is set START or FINISH, every speed is shown only as long as the "display time 1" in menu 4 is set. After the display time the display (5) shows zeros, the display board shows blank. If menu12 is set OFF, the speed is displayed until the beginning of the next measurement.

Printer: example for printout

Menu 31, print times = OFF

0001	km/h	144.23	first speed measurement
0002	km/h	120.08	second speed measurement

Menu 31, print times = ON

0001	C0	13:49:41.8506	1 st photocell impulse
0001	C1	13:49:42.1006	2 nd photocell impulse
	LZ	0:00.2490	run time between photocells
	km/h	144.23	1 st speed measurement
0002	C0	13:59:45.2414	1 st photocell impulse
	ZZ	13:59:45.5414	2 nd photocell impulse
	LZ	0:00:3001	run time between photocells
	km/h	120.08	2 nd speed measurement

Display board (D-LINE and GAZ):

Speed and start number/rank can be displayed each on an ALGE display board. The current number shown on display (6) is always displayed on the display board. On the display board, the number is only 3-digit, the rank 2-digit.

start number/
rank

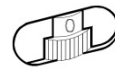
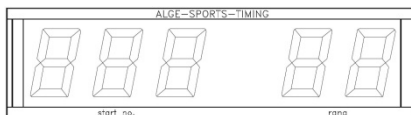

thumb-wheel switch
on 0



toggle switch
up

run time and
running time

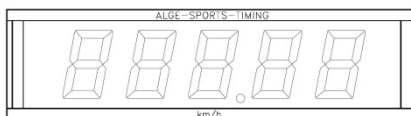

thumb-wheel switch
on 0



toggle switch
middle

RS232 interface: see chapter 8.2

6.6 Speed Skiing, Program 8

The program speed skiing measures time and speed for skiers who pass through two photocells with a distance of 100 m. With speed skiing program only one heat can be carried out.

measuring distance: 100 m (nonadjustable)

speed: km/h (nonadjustable)

channels: C0 start channel, C1 finish channel

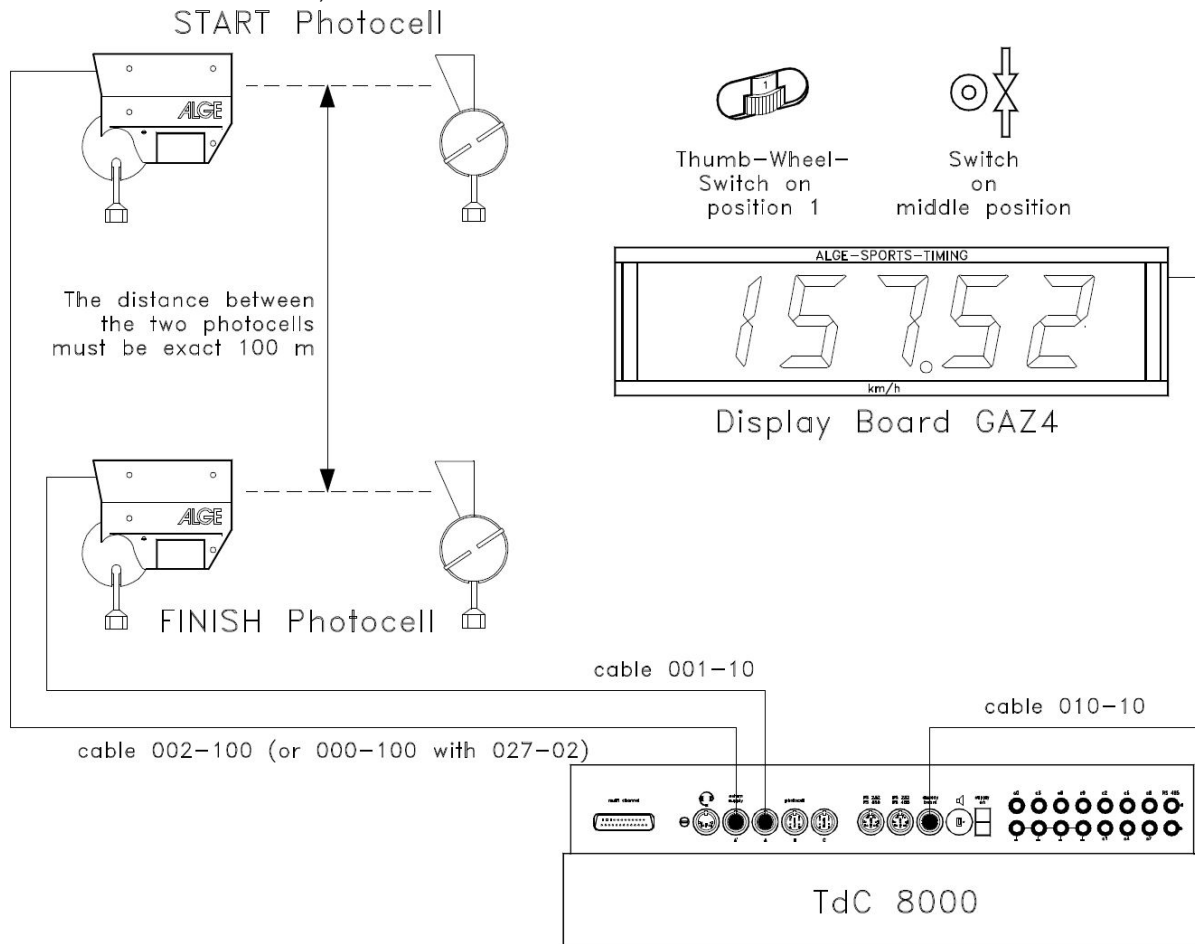

Activation procedure:

- turn on TdC 8001 (switch g)
- select program 8 Speed Skiing with cursor keys and <ENTER>
- clear memory for used race and <ENTER>
- select race and <ENTER>
- <YES> for entering groups, otherwise <NO> and <ENTER>
 - when entering groups, always enter last number of a group
 - confirm every input with <ENTER>
 - after start number of last group is entered, press <ENTER>
- synchronize TdC 8001 (possibly with other timing devices)
 - press <F1> in order to confirm indicated time of day
 - at next full minute a start impulse is issued via channel c0
 - TdC 8001 is ready for timing
 - press <F2> if display (5) shows wrong time of day
 - enter time with finish keypad (8) and confirm with <ENTER>
 - start clock with start signal (<START> or channel c0)

Race procedure:

- enter * and + on keypad (9), middle segment on display (1) is at the top
- press <MENU> and <ALT> at the same time
- select START in menu 12 (start number automatic)
- enter start number for start with start keypad (12) and <ENTER>

- display (1) must show correct start number (and group)
- start impulse for number 1 effected
- display (5) now shows running time, display (6) the started start number
- display (1) changes automatically to next start number
- when the competitor triggers the finish photocell, the running time is displayed; the time of day is printed with run time and speed
- start impulse for number 2 effected
- display (5) now shows running time, display (6) started start number
- display (1) changes automatically to next start number
- when the competitor triggers the finish photocell, the running time is displayed; time of day is printed with run time and speed
- etc.

When start number automatic is set to START, only one competitor must be on the course.

Channel assignment

c0 = start channel	c5 = no function
c1 = finish channel	c6 = no function
c2 = no function	c7 = no function
c3 = no function	c8 = no function
c4 = no function	c9 = no function

Default main menu:

Menu 1:	delay time start	=	1.0 sec.
Menu 2:	delay time finish	=	0.3 sec.
Menu 3:	seconds mode	=	off
Menu 4:	display time 1	=	3 sec.
Menu 6:	display thousandths	=	off
Menu 7:	info display	=	finish
Menu 9:	running tenth	=	off
Menu 11:	run time rank	=	on
Menu 12:	start number automatic	=	off
Menu 13:	automatic time	=	00:00:00.00
Menu 14:	print start time	=	off
Menu 16:	paperfeed	=	0
Menu 17:	RS232 baud rate	=	9600 baud
Menu 18:	RS232 run time	=	off
Menu 19:	d-board baud rate	=	2400 baud
Menu 20:	d-board channel 2	=	running
Menu 21:	beep	=	on
Menu 23:	groups	=	off
Menu 25:	change race		
Menu 26:	d-board test		
Menu 53:	bib-counting	=	manual
Menu 55:	LED-brightness	=	9
Menu 56:	delaytime to next StNo	=	3
Menu 59:	pulse from radio	=	alle Kanäle aus
Menu 62:	extern beep	=	alle Kanäle aus
Menu 63:	RS485 user	=	Wireless TN (WTN)

Printer: example of printout

0001	ST	11:47:59.9965	start time (1 st photocell)
	FT	11:48:02.0775	finish time (2 nd photocell)
	RT	0:02.081	run time
	SP km/h	172.99	speed in km/h
0002	ST	11:48:07.1017	start time (1 st photocell)
	FT	11:48:09.2666	finish time (2 nd photocell)
	RT	0:02.165	run time
	SP km/h	166.28	speed in km/h

Display board GAZ5:

Net time and start number/rank as well as speed can be shown on an **ALGE** display board. Always the current number indicated in display (6) is displayed (on display board number is 3-digit, rank 2-digit). In main menu (menu 20) channel 2 can be activated. If working with channel 2 only three stopped times are shown on display board (no running time).

start number/
rank

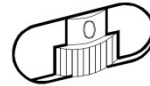
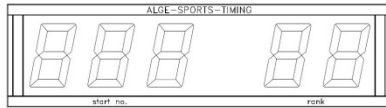

thumb-wheel switch
on 0



toggle switch
up

time

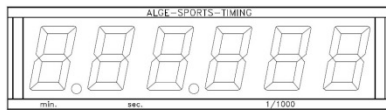

thumb-wheel switch
on 0



toggle switch
middle

speed

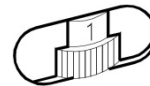
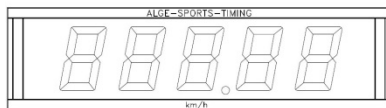

thumb-wheel switch
on 1



toggle switch
middle

RS232 interface: see chapter 8.2

6.7 Carving, Program 9

Count-down at zero with horn, after that time runs upwards starting at zero. The count-down time can freely be entered. Any number of competitors can be on the course at the same time. Up to eight intermediate times can be measured (c2 to c9). The program carving is only intended for one heat. A ranking is not possible as no points can be entered at the timing device.

Activation procedure:

- turn on TdC 8001 (switch g)
- select program CARVING with cursor keys and <ENTER>
- clear memory for used race and <ENTER>
- select race and <ENTER>
- select precision and <ENTER>
- select timing mode and <ENTER>
- select start mode and <ENTER>
- <YES> for entering groups, otherwise <NO> and <ENTER>
 - when entering groups, always enter the last number of a group
 - confirm every input with <ENTER>
 - if start number of last group is entered, press <ENTER>
- synchronize TdC 8001 (possibly with other ALGE timing devices)
 - press <F1> to confirm indicated time of day
 - at next full minute start impulse is issued via channel c0
 - TdC 8001 is ready for timing
 - press <F2> is display (5) shows wrong time of day
 - enter time with finish keypad (8) and confirm with <ENTER>
 - start clock with start signal (<START> or channel c0)

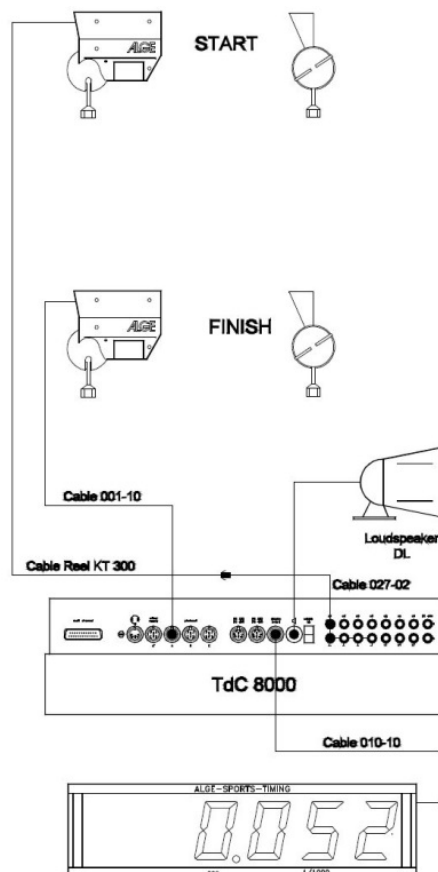

Race procedure:

- enter * and + on keypad (9), middle segment of displays (1) is at top
- press <MENU> and <ALT> at the same time
- go to menu 43: countdown time
- select menu 43 with <YES>
- enter desired countdown time (with keypad (9))
- confirm countdown time with <ENTER>
- exit menu by pressing <NO>
- enter start number for start with start keypad (12) and <ENTER>
- display (1) must show correct start number (and group)
- enter start number for finish with finish keypad (8) and <ENTER>
- display (8) must show correct start number (and group)
- start impulse for number 1 effected (from channel c0)
- display (1) changes automatically to next start number
- display (5) shows running countdown time
- finish impulse number 1 effected
- display (5) shows countdown time of number 1
- start impulse for number 2 effected
- display (1) changes automatically to next start number
- enter start number for finish with finish keypad (8) and <ENTER>
- display (5) shows running countdown time of number 2
- finish impulse number 2 effected
- display (5) shows countdown time of number 2
- etc.

Countdown time:

The countdown time for carving can be entered. Times from 0 to 23:59:59.99 are possible. This countdown time applies for all participants.

Countdown time 1 = 00:01:00.00

Save with: ENTER

enter countdown time

exit with <ENTER>

Key functions	Keypad (12) or (9)	Keypad (8) or (9)
clear start time	CLEAR	
restore last cleared start time	ALT + CLEAR	
clear finish time		CLEAR
restore last cleared finish time		ALT + CLEAR
block start time	BLOCK	
ignore start time	ALT + BLOCK	
block finish time		BLOCK
ignore finish time		ALT + BLOCK
no function	INPUT	INPUT

Channel assignment

- | | |
|------------------------|------------------------|
| c0 = start channel | c5 = intermediate time |
| c1 = finish channel | c6 = intermediate time |
| c2 = intermediate time | c7 = intermediate time |
| c3 = intermediate time | c8 = intermediate time |
| c4 = intermediate time | c9 = intermediate time |

Default main menu:





- | | | | |
|----------|---------------------------|---|-------------------|
| Menu 1: | delay time start | = | 1.0 sec. |
| Menu 2: | delay time finish | = | 0.3 sec. |
| Menu 3: | seconds mode | = | off |
| Menu 4: | display time 1 | = | 3 sec. |
| Menu 6: | display thousandths | = | off |
| Menu 7: | info display | = | finish |
| Menu 9: | running tenth | = | off |
| Menu 10: | intermediate time ranking | = | off |
| Menu 11: | run time ranking | = | on |
| Menu 12: | start number automatic | = | off |
| Menu 13: | automatic time | = | 00:00:00.00 |
| Menu 14: | print start time | = | off |
| Menu 16: | paperfeed | = | 0 |
| Menu 17: | RS232 baud rate | = | 9600 baud |
| Menu 18: | RS232 runt ime | = | off |
| Menu 19: | d-board baud rate | = | 2400 baud |
| Menu 20: | d-board channel 2 | = | running |
| Menu 21: | beep | = | on |
| Menu 23: | groups | = | off |
| Menu 25: | change race | | |
| Menu 26: | d-board test | | |
| Menu 43: | countdown time 1 | = | 00:01:00.00 |
| Menu 53: | bib-counting | = | manual |
| Menu 55: | LED-brightness | = | 9 |
| Menu 59: | pulse from radio | = | alle Kanäle aus |
| Menu 62: | extern beep | = | alle Kanäle aus |
| Menu 63: | RS485 user | = | Wireless TN (WTN) |

Printer: example of printout

0001	ST	10:30:17.0210	start time
	FT	10:30:45.8578	finish time
	RT	+1.17	allowed countdown time
0002	ST	10:31:01.5791	start time
	FT	10:31:32.9280	finish time
	RT	-1.33	countdown time exceeded

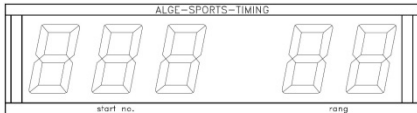
Display board (D-LINE and GAZ):

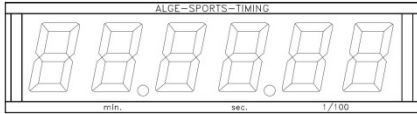
Countdown time and start number/rank can be shown each on an **ALGE** display board. The current number shown in display (6) is always displayed (on display board number 3-digit, rank 2-digit) in main menu (see menu 20) channel 2 can be activated. When working with channel 2, on the stopped time is shown on display board (no running time).

start number rank		 thumb-wheel switch on 0	 toggle switch up
countdown time		 thumb-wheel switch on 0	 toggle switch middle

RS232c interface:

Output format: 1 start bit, 8 data bit, no parity bit, 1 stop bit
Transfer rate: 9.600 baud preferred setting (2400, 4800, 9600, 19200)
Transfer protocol: ASCII

xNNNNxC0xxHH:MM:SS.zhtqxGR (CR)	start time
xNNNNxC1xxHH:MM:SS.zhtqxGR (CR)	finish time
xNNNNxRTx+HH:MM:SS.zhtxxGR (CR)	stopped countdown time (allowed)
xNNNNxRTx-HH:MM:SS.zhtxxGR (CR)	stopped countdown time (less than allowed time)
nNNNN (CR)	

x blank
 NNNN start number (4-digit)
 C0 start channel
 C1 finish channel
 RT countdown time
 + countdown stopped before reaching zero
 - countdown stopped after reaching zero
 GR group (from 01 to 99; 00 for no group)
 n new start number shown in finish display
 (CR) carriage return
 Following characters can be at 1st position:
 ? time without valid start number
 c cleared times (with <CLEAR>)

6.8 10-Channel Timer, Program 10

There are two 10-channel timer programs. The difference is in the output on display boards.

10-channel timer 1: output of times of all timing channels to one display board

10-channel timer 2: output of times of all timing channels to different display boards (addressed output of channels)

6.8.1 10-Channel Timer 1, Program 101

The 10-channel timer 1 is a very universal program with many application possibilities. It has a start channel (c0) and 9 finish channels (c1 to c9). Every finish channel can be assigned as often as desired with the same number (e. g. when timing laps for every lap the total time of the corresponding start number is shown).

Activation procedure:

- turn on TdC 8001 (switch g)
- select program 10-channel timer with cursor keys and <ENTER>
- clear memory for used race and <ENTER>
- select race and <ENTER>
- select precision and <ENTER>
- select start mode and <ENTER>
- <YES> for entering groups, otherwise <NO> and <ENTER>
 - when entering groups, always enter last number of a group
 - confirm every input with <ENTER>
 - after start number of last group press<ENTER>
- synchronize TdC 8001 (possibly with other timing devices)
 - press <F1> for confirming indicated time of day
 - at next full minute a start impulse is issued via channel c0
 - TdC 8001 is ready for timing
 - press <F2> if display (5) shows wrong time of day
 - enter time with finish keypad (8) and confirm with <ENTER>
 - start clock with start signal (<START> or channel c0)

Race procedure:

- enter * and + on keypad (9), middle segment of display (1) is at top
- enter start number for start with start keypad (12) and <ENTER>
- display (1) must show correct start number (and group)
- enter start number for finish with finish keypad (8) and <ENTER>
- display (6) must show correct start number (and group)
- start impulse for number 1 effected (from channel c0)
- display (1) changes automatically to next start number
- display (5) shows running time
- impulse c1 for number 1 effected
- display (5) shows run time (c1) of number 1
- impulse c2 for number 1 effected
- display (5) shows run time (c2) of number 1
- impulse c1 for number 1 effected
- display (5) shows new run time (c1) of number 1
- impulse c2 for number 1 effected
- display (5) shows new run time (c2) of number 1
- etc.

Any number of competitors can be on the course at the same time. Any number of stop impulses for each competitor can be executed with any channel (c1 to c9). The rank can be display for all channels jointly (total rank) or for every channel separately (menu 30: rank calculation).

Key functions	Keypad (12) or (9)	Keypad (8) or (9)
clear start times	CLEAR	
restore last cleared start time	ALT + CLEAR	
clear finish time c1		CLEAR
restore last cleared finish time c1		ALT + CLEAR
block start time	BLOCK	
ignore start time	ALT + BLOCK	
block finish time c1		BLOCK
block finish time c1		ALT + BLOCK
edit start times	INPUT	
edit finish times		INPUT

Channel assignment

c0 = start channel	c5 = finish channel
c1 = finish channel	c6 = finish channel
c2 = finish channel	c7 = finish channel
c3 = finish channel	c8 = finish channel
c4 = finish channel	c9 = finish channel

Default main menu:

Menu 1:	delay time start	=	1.0 sec.
Menu 2:	delay time finish	=	0.3 sec.
Menu 3:	seconds mode	=	off
Menu 4:	display time 1	=	3 sec.
Menu 6:	display thousandths	=	off
Menu 7:	info display	=	finish
Menu 9:	running tenth	=	off
Menu 11:	run time rank	=	on
Menu 12:	start number automatic	=	off
Menu 13:	automatic time	=	00:00:00.00
Menu 14:	print start times	=	off
Menu 16:	paperfeed	=	0
Menu 17:	RS232 baud rate	=	9600 baud
Menu 18:	RS232 run time	=	off
Menu 19:	d-board baud rate	=	2400 baud
Menu 20:	d-board channel 2	=	laufend
Menu 21:	beep	=	on
Menu 23:	groups	=	off
Menu 25:	change race		
Menu 26:	d-board test		
Menu 30:	rank calculation	=	separate
Menu 53:	bib-counting	=	manual
Menu 55:	LED-brightness	=	9
Menu 56:	delaytime to next StNo	=	3
Menu 59:	pulse from radio	=	alle Kanäle aus
Menu 62:	extern beep	=	alle Kanäle aus
Menu 63:	RS485 user	=	Wireless TN (WTN)

Printer: example of printout

0001 SZ	10:52:04.9900	start time
C1	10:52:49.8958	Finish time
LZ	0:44.90	Run time channel 1 (erste Zeit von Startnr. 1 auf channel 1)
0001 SZ	10:52:04.9900	Start time
C2	10:52:49.8958	Finish time
LZ	0:45.47	Run time channel 2
0001 SZ	10:52:04.9900	Start time
C1	10:52:51.5165	Finish time
LZ	0:46.52	Run time channel 1 (zweite Zeit v. Startnr. 1 auf channel 1)

Display board (D-LINE and GAZ):

The run time (running time) and start number/rank can be displayed each on an **ALGE** display board. The current number indicated on display (6) is always displayed (on display board number 3-digit, rank 2-digit). In main menu (see menu 20) channel 2 can be activated. When working with channel 2, only the stopped time is shown on display board (no running time).

start number
rank

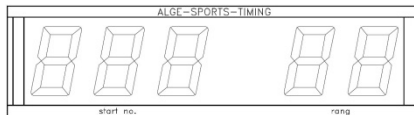

run time and
running time

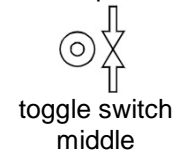
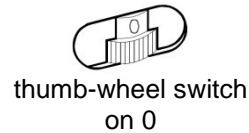
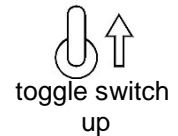
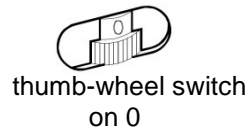
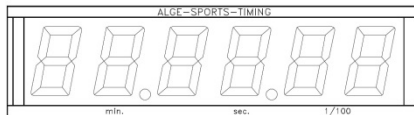

RS232c Interface: see chapter 8.2

6.8.2 10-Channel Timer 2, Program 102

The 10-channel timer 2 is a universal program with many application possibilities. It has a start channel (c0) and nine finish channels (c1 to c9). Every finish channel can be assigned with any number of the same number. Output of timing channels c1 to c9 is addressed to separate display boards. Main purpose of this program is to time runs with several courses, joint starts and separate finishes.

Example:

Four competitors are to start at the same time, each on a separate course. In the finish every competitor is stopped by a separate photocell. Every time is shown separately on a display board.

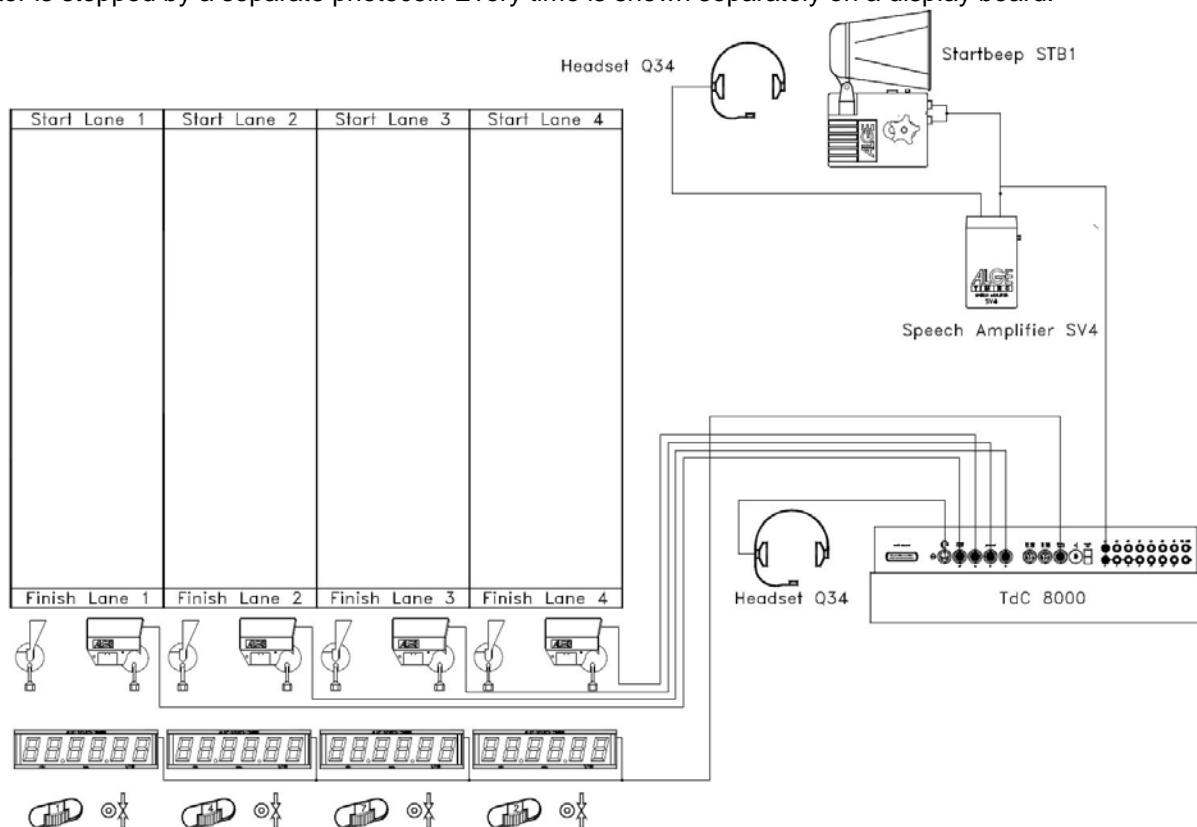

- lane 1: channel 1 cable 001-xx on jack A
- lane 2: channel 4 cable 001-xx on jack B
- lane 3: channel 7 cable 001-xx on jack C
- lane 4: channel 2 cable 003-xx on jack A'

- display board on position 1
- display board on position 4
- display board on position 7
- display board on position 2

When charging the TdC 8001 during timing the photocell adapter 018--5 is required. The photocell adapter is connected at jack A. Photocell cable and net supply device are connected at adapter.

Activation procedure:

- turn on TdC 8001 (switch g)
- select program 10-channel timer with cursor keys, <ENTER>
- select program 10-channel timer 2 with cursor keys, <ENTER>
- clear memory for used race, <ENTER>
- select race, <ENTER>
- select precision, <ENTER>
- select timing mode, <ENTER>
- select start mode, <ENTER>
- press <YES> for entering groups otherwise <NO> and <ENTER>
 - when entering groups always enter last number of the group
 - confirm every input with <ENTER>
 - after entering start number of last group, press <ENTER>
- synchronize TdC 8001 (possibly with other timing devices)
 - press <F1> for confirming time of day

- at next full minute a start impulse is issued via c0
- TdC 8001 is ready for timing
- press <F2> if display (5) shows a wrong time of day
 - enter time with finish keypad (8) and confirm with <ENTER>
 - start clock with start signal (<START> or channel c0)

Race procedure:

- enter * and + on keypad (9) middle segment on display (1) is at top
- enter number of heat for start with start keypad (12) and <ENTER>
- display (1) must show correct heat number (and group)
- enter heat number for finish with finish keypad (8) and <ENTER>
- display (6) must show correct heat number (and group)
- start impulse for heat 1 effected (from channel c0)
- display (1) changes automatically to next start number
- display (5) shows running time
- impulse c1 for lane 1 effected
- impulse c4 for lane 2 effected
- impulse c7 for lane 3 effected
- impulse c2 for lane 4 effected

All times are displayed one underneath the other in the info display (5) (if info display is set to finish (menu 7)). For every lane any number of impulses can be received. The time is always shown on the display and the display board for the time set in "display time 2". The "display time 2" start anew with every impulse. If set to zero, the time stops until a new impulse arrives or until it is set to a new heat.

Key functions	Keypad (12) or (9)	Keypad (8) or (9)
clear start time	CLEAR	
restore last cleared start time	ALT + CLEAR	
clear finish time c1		CLEAR
restore last cleared finish time c1		ALT + CLEAR
block start time	BLOCK	
ignore start time	ALT + BLOCK	
block finish time c1		BLOCK
ignore finish time c1		ALT + BLOCK
edit start times	INPUT	
edit finish times		INPUT

Channel assignment

- | | |
|---------------------|---------------------|
| c0 = start channel | c5 = finish channel |
| c1 = finish channel | c6 = finish channel |
| c2 = finish channel | c7 = finish channel |
| c3 = finish channel | c8 = finish channel |
| c4 = finish channel | c9 = finish channel |

Default main menu:

- | | | | |
|----------|--------------------|---|----------|
| Menu 1: | delay time start | = | 1.0 sec. |
| Menu 2: | delay time finish | = | 0.3 sec. |
| Menu 3: | seconds mode | = | off |
| Menu 4: | display time 1 | = | 3 sec. |
| Menu 5: | display time 2 | = | 3 sec. |
| Menu 6: | display thousandth | = | off |
| Menu 7: | info display | = | finish |
| Menu 9: | running tenth | = | off |
| Menu 11: | run time rank | = | on |

Menu 12:	start number automatic	=	off
Menu 13:	automatic time	=	00:00:00.00
Menu 14:	print start time	=	off
Menu 16:	paperfeed	=	0
Menu 17:	RS232 baud rate	=	9600 baud
Menu 18:	RS232 run time	=	off
Menu 19:	d-board baud rate	=	2400 baud
Menu 20:	d-board channel 2	=	running
Menu 21:	beep	=	on
Menu 23:	groups	=	off
Menu 25:	change race		
Menu 26:	d-board test		
Menu 30:	rank calculation	=	separate
Menu 53:	bib-counting	=	manual
Menu 55:	LED-brightness	=	9
Menu 56:	delaytime to next StNo	=	3
Menu 59:	pulse from radio	=	alle Kanäle aus
Menu 62:	extern beep	=	alle Kanäle aus
Menu 63:	RS485 user	=	Wireless TN (WTN)

Printer: example of printout

0001	ST	10:52:04.9900	start time channel 1 (lane 1)
	C1	10:52:49.8958	finish time channel 1 (lane 1)
	RT	0:44.90	run time channel 1 (lane 1)
0001	ST	10:52:04.9900	start time channel 4 (lane 2)
	C4	10:52:49.4672	finish time channel 4 (lane 2)
	RT	0:45.47	run time channel 4 (lane 2)
0001	ST	10:52:04.9900	start time channel 2 (lane 4)
	C2	10:52:51.4672	finish time channel 2 (lane 4)
	RT	0:45.47	run time channel 2 (lane 4)
0001	ST	10:52:04.9900	start time channel 7 (lane 3)
	C7	10:52:51.5165	finish time channel 7 (lane 3)
	RT	0:46.52	run time channel 7 (lane 3)

Display board GAZ5:

Up to nine display boards can be connected (for up to nine lanes). Every display board must be addressed separately with the thumb-wheel switch. The display board with address 1 also shows the running time; all others do not. Channel 2 can be activated in main menu (see menu 20). When working with channel 2 only the stopped time is displayed on the display board (no running time).

run time and
running time

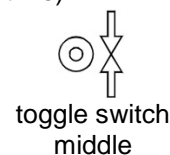
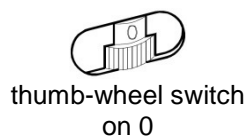
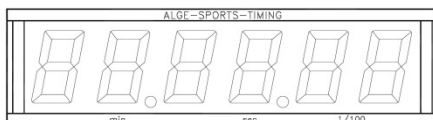

The time is always displayed for the duration set in "display time 2" (menu 5). If "display time 2" is set to zero, every time is shown until deleted by a further impulse of the same channel.

The "display time 2" starts with every impulse for alle channels anew.

RS232c Interface: see chapter 8.2

RS485 Interface: no function

6.9 Equestrian Sport, Program 11

There are different competitions for showjumping. The standard competitions are supported by the different showjumping programs.

– Table A1	FEI article 238.1.1	program 111
– Table A2	FEI article 238.2.1	program 112
– Table AM3	FEI article 238.1.2	program 113
– Table AM4	FEI article 238.1.3	program 114
– Table AM5	FEI article 238.2.2	program 115
– Table AM6	FEI article 238.2.3	program 116
– Table AM7	FEI article 273.3.3.1 und 273.4.1	program 117
– Table AM8	FEI article 273.3.3.2 und 273.4.3	program 118
– Table AM9		program 119
– Table B1	FEI article 269	program 120
– Table B2	FEI article 269	program 121
– Table B3	FEI article 269	program 122
– Table C	FEI article 239	program 123
– Two Stage Jumping	FEI article 274.5.2	program 124
– American Stage F		program 125
– American Stage F / Time		program 126
– Standard / Time 1	FEI article 274.5.4	program 127
– Standard / Time 2	FEI article 274.5.5	program 128
– Team Jumping 1		program 129
– Team Jumping 2		program 130
– Team Jumping 3		program 131
– Team Jumping 4		program 132
– Table A Time Delayed		program 133

The programs for equestrian sport are not described in this manual. A separate manual for equestrian sport can be downloaded from our website (www.alge-timing.com) or acquire at your **ALGE** representation.

6.10 Speed Skating, Program 12

This program for speed skating was designed with emphasis on easy handling. As long as no lapping or dropping out occurs, the TdC 8001 does not have to be operated during the race.

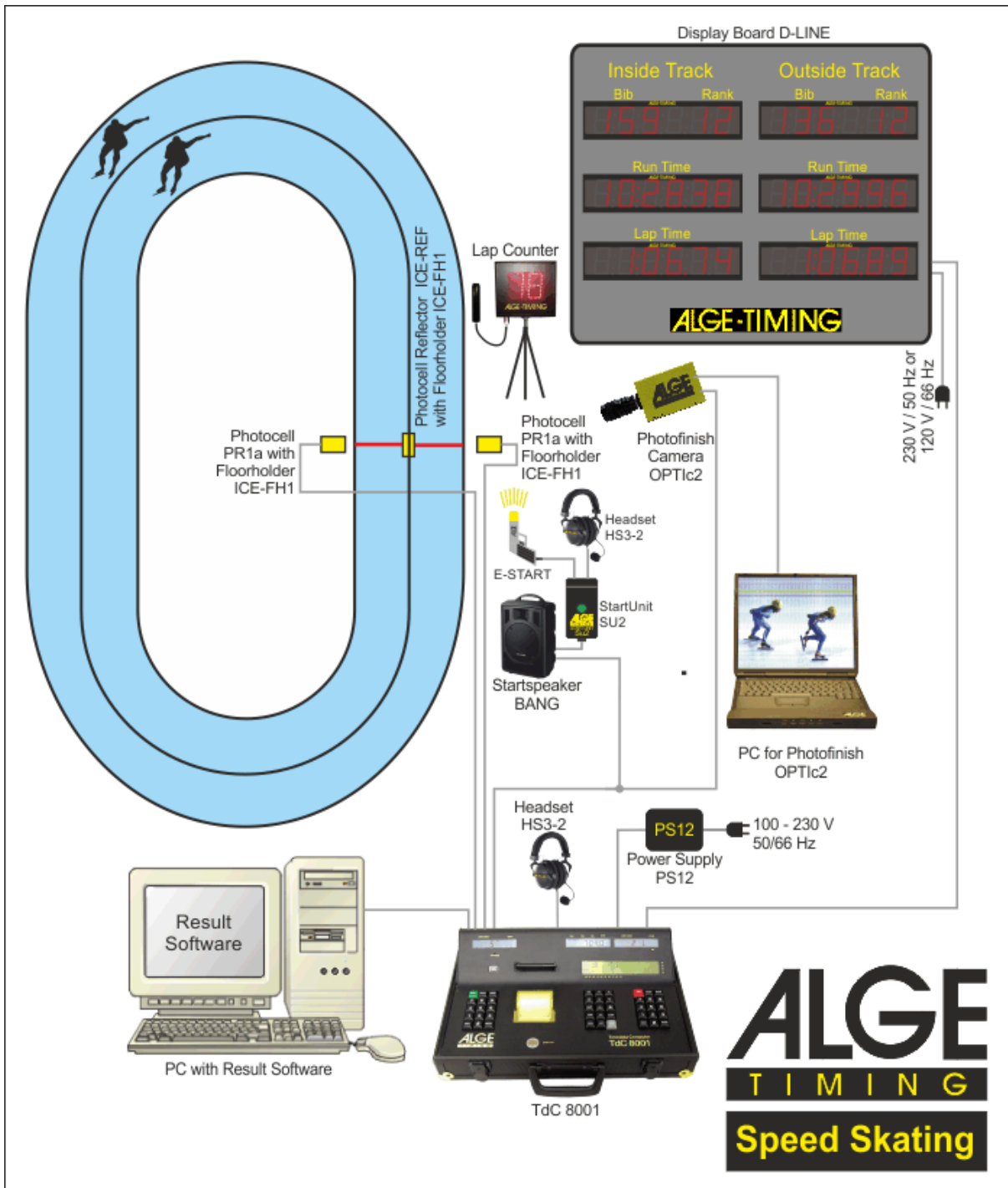

Operating the TdC 8001

Inside lane:

The competitor starting on the inside lane is maintained as inside lane competitor for the whole race (on TdC 8001 display and display board).

Outside lane:

The competitor starting on the outside lane is maintained as outside lane competitor for the whole race (on TdC 8001 display and display board).

Used impulse channels:

start channel	c0	cable 000-xx (or cable reel) (jack h – c0)
photocell inside lane	c1	cable 001-xx (jack A or A') or 000-xx (jack h – c1)
photocell outside lane	c4	cable 001-xx (jack B) or 000-xx (jack h – c4)

Change of lanes:

The change of lanes was integrated in the TdC 8001 software. Only in case of a lapping or when a competitor does not reach the finish, this must be entered into the TdC 8001 (see below).

Lapping:

When a competitor laps another, press <MEMO> and enter the next times manually with <INPUT>.

Competitor does not reach the finish (give-up or falls):

When a competitor does not reach the finish it has to be entered into TdC 8001. Press <ALT> and <ENTER> (on keypad of dropped out competitor) so that for the rest of the race the lane changes are correctly assigned to the remaining competitor.

Lane is not occupied at the start:

If a lane stays free at the start, start number 0 and <ENTER> has to be entered. Then, no start number is shown for this lane. The impulse selection is effected automatically.

Activation procedure:

- turn on TdC 8001 (switch g)
- select program 12 – speed skating with cursor keys, <ENTER>
- clear memory for used race, <ENTER>
- select race, <ENTER>
- synchronize TdC 8001 (possibly with other timing devices)
 - press <F1> to confirm the indicated time of day
 - at next full minute a start impulse is issued via channel c0
 - TdC 8001 is ready for timing
 - press <F2> is display (5) shows wrong time of day
 - enter time with finish keypad (8) and confirm with <ENTER>
 - start clock with start signal (<START> or channel c0)
- selection
 - NEW – a new race is started
 - OLD – timing of existing race is continued
 - TDC-MENU – TdC Menu is opened
 - CLEAR – memory is cleared
- select race distance with cursor keys
- TdC 8001 is ready for the race

Race procedure:

- enter start number of inside lane competitor with keypad (12)
- confirm with <ENTER>
- enter start number of outside lane competitor with keypad (8)
- confirm with <ENTER>
- enter start number 0 for a free lane

The impulses are automatically received correctly as long as both competitors reach the finish and no lapping occurs.

Info display (7) shows all times of the race. The left side shows information for the inside lane competitor, the right one for the outside lane competitor. You can browse with the cursor keys between the times. On the right of the time is always the distance at which the time is measured. At the run time the total rank is displayed.

If both competitors reach the finish, the start numbers for the next competitor couple can be entered.

General information for use:

start keypad (12):	to enter the start number for inside lane competitor
finish keypad (8):	to enter the start number for the outside lane competitor
cursor keys:	to move the cursor in info display (7)
<START>:	manual start impulse (both lanes) and manual stop impulse for inside lane

<p><STOP>: <MEMO>: <INPUT>: <CLEAR> during race: <CLEAR> during MEMO: <CLEAR> during Menu: <ALT> and <CLEAR>: <ALT> and <ENTER>: <CLASS>: <ALT> and <CLASS>: <*>: <F4>:</p>	<p>manual stop impulse for outside lane times are stored and can later be assigned with <INPUT> to the correct competitor time stored with <MEMO> can be assigned to the competitors - INPUT of keypad (12) for inside and INPUT of keypad (8) for outside the last time of competitor (inside or outside) is cleared time marked with cursor is cleared the last time of competitor (inside or outside) is cleared last cleared time of this competitor is restored, only possible as long as competitor did not receive new time input that competitor gave up (e. g. fall) print current ranking print ranking on RS232 interface output all times on RS232 interface to select new race or change to existing race (only active when start number can be entered)</p>
--	---

Channel assignment

c0 = start channel	c5 = no function
c1 = finish for inside lane	c6 = no function
c2 = no function	c7 = no function
c3 = no function	c8 = no function
c4 = finish for outside lane	c9 = no function

Default main menu:

Menu 1:	delay time start	=	1.0 sec.
Menu 2:	delay time finish	=	0.3 sec.
Menu 4:	display time 1	=	3 sec.
Menu 16:	paperfeed	=	0
Menu 17:	RS232 baud rate	=	9600 baud
Menu 19:	d-board baud rate	=	2400 baud
Menu 21:	beep	=	on
Menu 25:	change race		
Menu 26:	d-board test		
Menu 53:	start number stepping	=	upwards
Menu 55:	LED-brightness	=	9
Menu 59:	pulse from radio	=	alle Kanäle aus
Menu 62:	extern beep	=	alle Kanäle aus
Menu 63:	RS485 user	=	Wireless TN (WTN)

Printer: example of printout

0018	ST	10:00:00.1000	start time start number 18
0023	C1	10:00:00.1000	start time start number 23
0018	200m	00:15.1287	intermediate time start no 18 at 200 m
0023	200m	00:15.2841	intermediate time start no 23 at 200 m
0023	600m	00:35.4567	intermediate time start no 23 at 600 m
0018	600m	00:35.8714	intermediate time start no 18 at 600 m
0023	FT	10:00:54.7567	finish time start no 23
0023	1000m	00:54.6567	run time start no 23 (1000 m)
0018	FT	10:00:54.9731	finish time start no 18
0018	1000m	00:54.8731	run time start no 18 (1000 m)

Display board (D-LINE and GAZ)

Three display boards can be connected for each lane; one shows the running time, one the start number or after finishing the rank, a further additionally the lap time.

run time and
running time

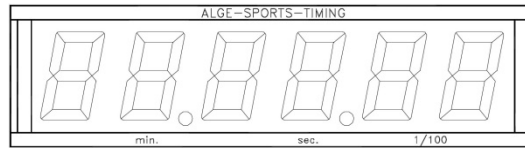

start number
and rank

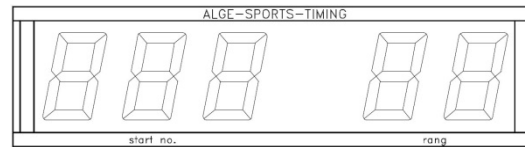

lap time

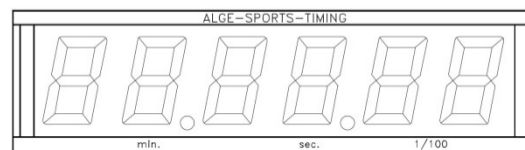

RS232 Interface: see chapter 8.2

6.11 Cycling, Program 13

6.11.1 Road Races, Program 131

The program dual timer was changed for road races. At the start the run time for all racers is shown. When the first cyclist finishes the time stops for him. On the display board the winner run time and the average speed is displayed. At the same time the clock starts for another display board on which the lag is shown for the other cyclists. This program can also be used for running events, triathlon etc. Attention: channel c1 and c3 or c4 and c0 must be shorted with banana plugs.

Activation procedure:

- turn on TdC 8001 (switch g)
- select program cycling with cursor keys, <ENTER>
- select program cycling road with cursor keys, <ENTER>
- clear memory for used race, <ENTER>
- select race, <ENTER>
- select precision, <ENTER>
- press <YES> for entering groups otherwise <NO> and <ENTER>
 - when entering groups always enter the last number of a group
 - confirm every input with <ENTER>
 - after the start number of the last group is entered, press <ENTER>
- synchronize TdC 8001 (possibly with other timing devices)
 - press <F1> to confirm indicated time of day
 - at next full minute a start impulse is issued via channel c0
 - TdC 8001 is ready for timing
 - press <F2> if display (5) shows wrong time of day
 - enter time with finish keypad (8) and confirm with <ENTER>
 - start clock with start signal (<START> or channel c0)

Race procedure:

- short channel c1 and c3
- press <ALT> and <MENU> at the same time
- select menu 32 „DISTANCE“ and <YES>
- enter length of course (from start to finish), <ENTER>
- enter number on keypad (8), <ENTER>
- enter number on start keypad (12), <ENTER>
- start race via channel c0
- the lower time start to run on info display (7)
- finish impulse for winner must be received via channel c1 or c3
- lower time in display stops, next to it average speed is shown
- simultaneously time of no. 2 is started, this time indicates lag of following cyclists
- with channel c4 lag time can be stopped
- press <CLEAR> (start keypad (9)) for lag time continuation
- etc.

Clear times:

Press <CLEAR> of keypad (12 or 8) to stop the corresponding finish impulse or lag time. With <ALT> and <CLEAR> the previously cleared finish time (lag time) can be restored.

Block times:

The finish time (lag time) can be blocked. Press <BLOCK> of keypad (12 or 8) to print the corresponding time as invalid (time of day with ?). With <ALT> and <BLOCK> the corresponding impulse is swallowed.

Edit times:

The times can be copied from one start number to another, invalid can be made valid or manually entered. <INPUT> of keypad (12 or 8) is used.

- <INPUT> changes finish or lag time
- <ALT> and <INPUT> changes start time for run or lag time

Rank calculation:

Rank calculation must be deactivated (menu 30: rank calculation)

Start channel:

The start must only be effected for run time (channel c0). The lag is automatically started with finish impulse of run time (channel c1 or c3). Both channels must in any case be shorted.

Identification:

Run time is marked with "r", lag time with "b" (or "L")

Channel assignment

c0 = start channel run time	c5 = intermediate time 1 (lag)
c1 = finish channel run time	c6 = intermediate time 2 (run time)
c2 = intermediate time 1 (run time)	c7 = intermediate time 2 (lag)
c3 = start channel lag time	c8 = intermediate time 3 (run time)
c4 = finish channel lag time	c9 = intermediate time 3 (lag)

Default main menu:

Menu 1:	delay time start	=	1.0 sec.
Menu 2:	delay time finish	=	0.3 sec.
Menu 3:	seconds mode	=	off
Menu 4:	display time 1	=	3 sec.
Menu 5:	display time 2	=	3 sec.
Menu 8:	running time	=	run
Menu 9:	running tenth	=	off
Menu 10:	intermediate time rank	=	on
Menu 11:	run time rank	=	on
Menu 14:	print start time	=	off
Menu 16:	paperfeed	=	0
Menu 17:	RS232 baud rate	=	9600 baud
Menu 18:	RS232 run time	=	off
Menu 19:	d-board baud rate	=	2400 baud
Menu 20:	d-board channel 2	=	running
Menu 21:	beep	=	on
Menu 22:	handicap time	=	00:00:00.00
Menu 23:	groups	=	off
Menu 24:	change heat		
Menu 25:	change race		
Menu 26:	d-board test		
Menu 27:	ID channel 4	=	b (blue)
Menu 30:	rank calculation	=	separate
Menu 33:	measuring unit	=	km/h
Menu 49:	distance	=	100 m
Menu 55:	LED-brightness	=	9
Menu 59:	pulse from radio	=	alle Kanäle aus
Menu 62:	extern beep	=	alle Kanäle aus
Menu 63:	RS485 user	=	Wireless TN (WTN)

Printer: example of printout

0002 r	ST	15:00:00.0000	Start time of field
	FT	15:09:53.6657	finish time of winner
	RT	9:53.66	run time of winner
0001	ST	15:09:53.6657	start time for lag timer = finish time of winner
	FT	15:10:01.3638	finish time of 1 st chasing group
	RT	0:07.69	lag of 1 st chasing group
c 0001 b	FT	15:10:01.3638	finish time of 1 st chasing group cleared with <CLEAR>
	RT	0:07.69	so that a new running lag time is available
0001 b	ST	15:09:53.6657	start time for lag timer = finish time of winner
	FT	15:10:11.9762	finish time of 2 nd chasing group
	RT	0:18:31	lag of 2 nd chasing group

Display board (D-LINE and GAZ):

winner time
running time

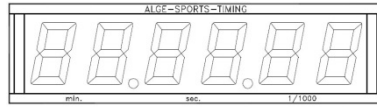

lag time

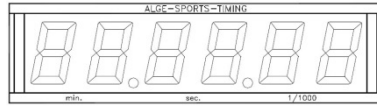

average speed

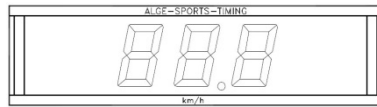

Channel 2 can be activated in main menu (see menu 20). When working with channel 2 only the stopped time is shown on display board (no running time).

RS232 Interface: see chapter 8.2

6.12 Dog Sports, Program 14

There are different competitions for dog sport agility. The standard program "challenge" is available in TdC 8001.

6.12.1 Challenge, Program 141

The programs for agility are not described in this manual. The program is almost identical with the program show jumping. We recommend to use the separate manual for show jumping to work with this program.

6.13 TdC Test, Program 15

With this program device testing as well as check of display and keypad can be carried out. The test program is used for tests after production. The TdC test is a manufacturer test and has no significance for the normal operation.

Activation procedure:

- turn on TdC 8001 (switch g)
- select program TdC TEST (prog. no. 9) with cursor keys, <ENTER>
- info display (7) shows

```
Menu 48: GENERAL MEASUREMENTS

Select: YES/NO or menu number: 48
```

- select desired program with cursor keys:
 - general measurements menu 48
 - display test menu 49
 - keypad test menu 50
 - confirm with <ENTER>

General measurements, menu 48

When selecting general measurements, the info display shows as follows:

Menu 48: GENERAL MEASUREMENTS	BATT	F1	battery test
UB= 8.5V IB=+0.00A TB=+23.9°	CLOCK	F2	clock of RS485
UE= 5.0V IE=+0.00A TL=-69.5°	PRINTER	F3	printer test
Continue: ENTER	SPEAKER	F4	speaker test

Info display (7) shows in second line the battery voltage (UB), the battery energy (IB) and battery temperature (TB). In third line the stabilized external voltage (UE) is indicated. It should be about 5 V. Further the charging rate of extender devices (IE) is shown. Extender devices are connected to RS485 interface. The current must remain below 1A. In addition a measurement with TL is shown. This measurement has not yet been activated and can indicate any value.

Check battery with <F1>:

- Press <F1> until info display (7) shows BATT L<. This means that the battery is charged when the charging device is connected. (IB) must show positive value (about +2 A)
- Press <F1> until info display (7) shows BATT E<. This means that the battery is discharged. The energy (IB) must show negative value (about - 1.6 A).

With <F2> the CLOCK impulse of the RS485 interface is checked with oscilloscope

With <F3> the character set of the printer is issued

With <F4> the external speaker is operated

Display test, menu 49

When selecting display test, the info display shows as follows:

Menu 49: DISPLAY TEST	DISPLAY 1	F1	test of display (1)
	DISPLAY 2	F2	test of display (5)
	DISPLAY 3	F3	test of display (6)
Continue: ENTER	DISPLAY 4	F4	test of display (7)

For the numerical displays (1, 5, 6) applies:

- pressing the F key for the first time, the display shows segment after segment
- pressing the F key again, the display shows all segments
- pressing the F key again, the display goes blank

For the alpha numeric display (7) applies:

- pressing F4, the display goes blank
- pressing F4 again, the display shows all points
- pressing F4 again, the display shows once more menu 49

Keypad test, menu 50

When selecting the keypad test, the info display shows as follows:

Menu 50: keypad test
U SCB 123 YFU TFC SCB 123
M 789 IOE NFD MAM 789 IOE
D 456 PE* 456

All keys can be tested. Every key that is pressed vanishes as long as it is pressed from the display. if the keys are pressed in the correct order, the cursor always steps to the next key. Begin with menu 53 for start number input at the top, middle, bottom and then start keypad (12) from left top to right bottom. Subsequently the function keypad (9) and finish keypad (8).

Exit by pressing <ALT> and <ENTER> of finish keypad (8).

channel test:	MENU 51	to test channels
interface test:	MENU 52	to test interfaces
RAM test:	MENU 53	to test internal RAM
RTC test (real time clock):	MENU 54	to adjust real time clock
subvoltage test:	MENU 55	to test the voltage threshold for device switch-off

You can only exit TdC test by switching off the TdC.

7 Description of Accessory Devices

7.1 Multichannel MC18

The MC 18 is used when the TdC 8001 is applied as 10-channel timer. The MC 18 has wired all 10 channels to banana jacks (channel 0 to 9, 10 to 17 are not activated). The MC 18 is connected at "multi channel" (a).



8 Technical Data

Measuring range	23 hours, 59 minutes, 59.9999 seconds
Time reference	TCXO 11.520 MHz (temperature compensated quartz oscillator)
Frequency deviation	at -25 to +50°C +/- 2,5 ppm at +/- 0,009 sec./hrs. with ageing +/- 1 ppm per year calibrated +/- 0,1 ppm at 25°C
Range of use	-25 to + 50°C
Memory:	ca. 2 x 8,600 times with start numbers internal rechargeable batteries, data storage also with off device
Display	start display (1) numeric liquid crystal display 8-digit, figure height 12.7 mm run time display (5) numeric liquid crystal display 8-digit, figure height 12.7 mm finish display (6) numeric liquid crystal display 8-digit, figure height 12.7 mm info display alpha numeric liquid crystal display 4 x 40 characters, figure height 4.8 mm
Control elements	on/off switch (g) menu 53 start keypad (12) with 15 keys function keypad (9) with 15 keys finish keypad (8) with 15 keys
Electronics	C-MOS technology with 80C167 micro processor
Energy supply	internal NiCd rechargeable battery 7.2 V / 4.5 Ah external 210 – 240 VAC with power charging unit PS12
Power consumption	without peripheral device from internal battery ca. 80 mA during printing ca. 500 mA
Charging voltage	+11 to 16 VDC (pin 4 from jack 19, 20, 21 and 22)
Impulse input	input resistance 10 kOhm against + 5 V triggering with < 1 V falling flank hysteresis ca. 2 V
Output with 5 VDC stabilized	total maximum 120 mA
Speaker output	for 8 W speaker, $U_{max} = 24 V_{pp}$
Casing	lockable case with removable lid, front plate from aluminum
Dimensions	450 x 320 x 150 mm
Weight	7.5 kg

8.1 Connection System

8.1.1 Photocell Jacks and External Supply

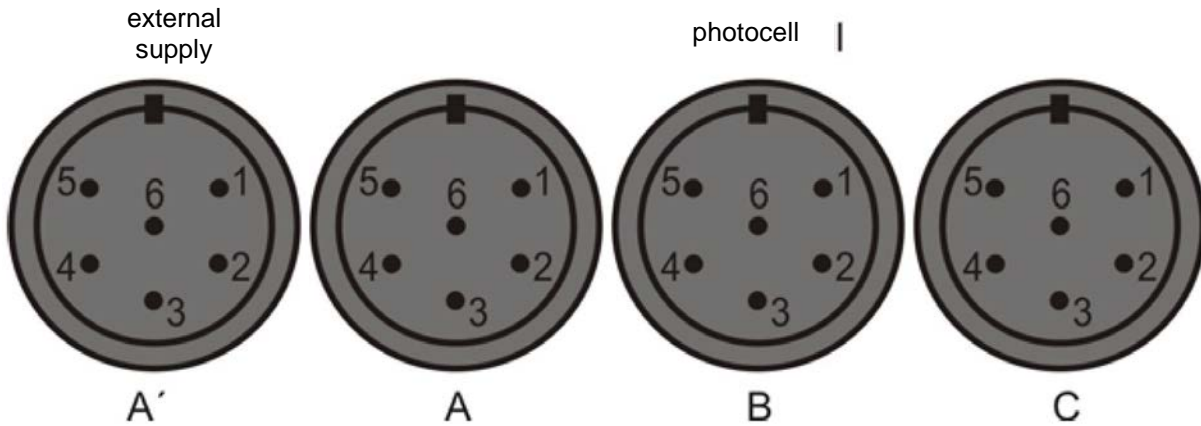

jacks A and A' (20 and 19)

- 1 input channel 0 (start)
- 2 input channel 1 (stop)
- 3 joint ground
- 4 input external supply (6 – 15 VDC)
- 5 output +5 VDC stabilized
- 6 input channel 2 (intermediate time)

jack C (C)

- 1 input channel 6 (start)
- 2 input channel 7 (stop)
- 3 joint ground
- 4 input external supply (6 – 15 VDC)
- 5 output + 5 VDC stabilized
- 6 input channel 8 (intermediate time)

jack B (B)

- 1 input channel 3 (start)
- 2 input channel 4 (stop)
- 3 joint ground
- 4 input external supply (6 – 15 VDC)
- 5 output + 5 VDC stabilized
- 6 input channel 5 (intermediate time)

8.1.2 Connection for Headset (c)

- 1 headset microphone
- 2 joint ground
- 3 headset ear pieces
- 4 joint ground
- 5 input channel 9

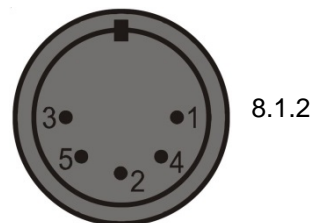

8.1.2

8.1.3 Speaker Jack (f)

- 1 speaker signal
- 2 joint ground



8.1.3

8.1.4 Display Board Jack (e)

TdC 8001 sold before 2008:

- 1 joint ground
- 2 output supply (6 – 15 VDC)
- 3 output data channel 1
- 4 output supply (6 – 15 VDC)
- 5 output data channel 1 or 2

TdC 8001 sold from 2008:

- 1 output data channel 1 or 2
- 2 joint ground
- 3 empty
- 4 empty
- 5 empty
- 6 empty
- 7 output supply (6 – 15 VDC)

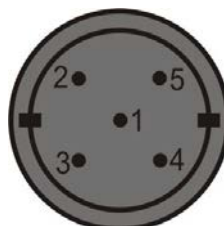

8.1.4
before 2008

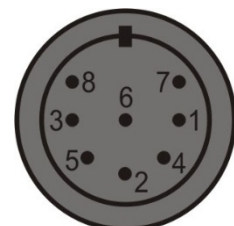

8.1.4
from 2008

8.1.5 RS232 / RS485 (d)

- 1 RS232, data TXD (transmit)
- 2 RS232, joint ground
- 3 RS232, data RXD (receive)
- 4 RS232, control line CTS
- 5 RS232, control line RTS
- 6 RS485, line a
- 7 RS232, output external supply
- 8 RS485, line b

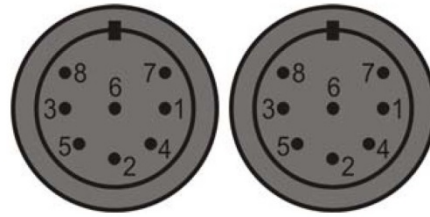

8.1.6 Display Board (i)

TdC 8001 sold before 2008:

Display board interface with data output channel 1 or 2 (yellow or white jack) and ground (black or blue jack). The channel can be set in the menu.

TdC 8001 sold from 2008:

Display board interface with data output channel 1 (yellow jack) and ground (black jack).



8.1.7 Banana Jacks Channel 0 to 9 (h)

All channels can be connected via banana jacks. Four ground connections (black) are available for the nine channels.

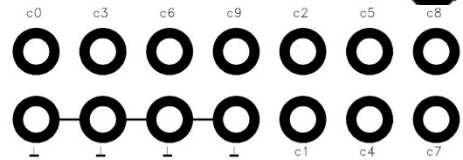

8.1.8 Multichannel (a)

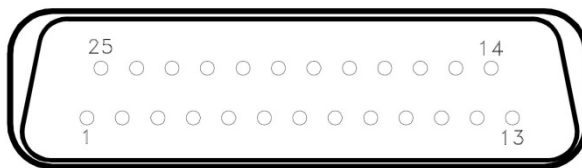

- | | |
|---|--|
| 1 channel 9 | 14 channel 1 |
| 2 channel 0 (start) | 15 channel 5 |
| 3 channel 2 | 16 channel 8 |
| 4 channel 3 | 17 channel 6 |
| 5 channel 7 | 18 channel 4 |
| 6 output data as channel 2 from „display board“ (e) | 19 empty |
| 7 RS485 B | 20 empty |
| 8 RS485 A | 21 empty |
| 9 clock A | 22 empty |
| 10 clock B | 23 output external supply (5.3 – 14.3 VDC) |
| 11 empty | 24 joint ground |
| 12 joint ground | 25 external supply (6 – 15 VDC) |
| 13 output +5 VDC stabilized | |

8.2 RS232 Interface (a, d)

output format

1 start bit, 8 data bit, no parity bit, 1 stop bit

transfer rate:

9,600 Bd preferred setting (adjustable: 2400, 4800, 19200)

transfer protocol

ASCII

- xNNNNxCCxxHH:MM:SS.zhtqxGR (CR)
- xNNNNxCCMxxHH:MM:SS.zhtqxGR (CR)
- xNNNNxRTxxHH:MM:SS.zhtxxGR (CR)
- xNNNNxTTxxHH:MM:SS.zhtxxGR (CR)
- xNNNNxSQxxHH:MM:SS.zhtxxGR (CR)
- xNNNNiCCxxHH:MM:SS.zhtxxGR (CR)
- xNNNNiRTxxHH:MM:SS.zhtxxGR (CR)
- xNNNNiCCxxHH:MM:SS.zhtqx## (CR)

- times from c0 to c9
- manually stopped time (with <START> or <STOP>)
- run time
- total time
- sequential time (lap time)
- dual timer, times from c0 to c9
- dual timer, run time
- parallel slalom, intermediate time or finish time

xNNNNiRTxxHH:MM:SS.zhtqx##(CR)	parallel slalom, run time
xNNNNiDTRxxHH:MM:SS.zhtxx##(CR)	parallel slalom, run difference time
xNNNNiTTxxHH:MM:SS.zhtqx##(CR)	parallel slalom, total time
xNNNNiDTT.HH:MM:SS.zhtxx##(CR)	parallel slalom, total difference time
pNNNNiCCxxHH:MM:SS.zhtqx##(CR)	parallel slalom, finish time calculated from penalty time
pNNNNiRTxxHH:MM:SS.zhtqx##(CR)	parallel slalom, run time calculated from penalty time
pNNNNiTTxxHH:MM:SS.zhtqx##(CR)	parallel slalom, total time calculated from penalty time
xNNNNxkmhxxxxsSSSS.ssxxxGR(CR)	speed measurement
xNNNNxkmhxxxxsSSSS.ssxxxx(CR)	speed measurement at speed skiing
?NNNNxCCxxHH:MM:SS.zhtqxGR(CR)	invalid time
m0000xCCxxHH:MM:SS.zhtqxGR(CR)	times of memo mode without assigned start number
cNNNNxCCxxHH:MM:SS.zhtqxGR(CR)	cleared time
dNNNNxCCxxHH:MM:SS.zhtqxGR(CR)	disqualified time
iNNNNxCCxxHH:MM:SS.zhtqxGR(CR)	edited (INPUT) time
xxxxxxC0xxHH:MM:SS.zhtqxGR(CR)	start time for group starts
xNNNNxRTx+HH:MM:SS.zhtxxGR(CR)	stopped countdown time (allowed)
xNNNNxRTx-HH:MM:SS.zhtxxGR(CR)	stopped countdown time (under allowed time)
nNNN(CR)	start number input with keypad

x.....	blank
NNNN.....	start number (4-digit)
0000.....	start number 0 always for times in memo mode
i.....	identification of course with dual timer
CC.....	channels of timing device
CCM.....	manual impulse (with <START> or <STOP> of keypad 12 or 8)
C0.....	channel 0 (start channel)
C1.....	channel 1 (finish channel)
C2.....	channel 2 (intermediate time)
C3.....	channel 3
C4.....	channel 4
C5.....	channel 5
C6.....	channel 6
C7.....	channel 7
C8.....	channel 8
C9.....	channel 9
RT.....	run time
TT.....	total time
SQ.....	sequential teit (lap time)
DTR.....	parallel slalom net: run difference time
DTT.....	parallel slalom net: total difference time
kmh.....	speed measurement (possible: kmh, mps, mph)
+.....	countdown was stopped before reaching zero
-.....	countdown was stopped after reaching zero
HH:MM:SS.zht.....	time in hours, minutes, seconds and 1/1000 seconds
HH:MM:SS.zhtq.....	time in hourse, minutes, seconds and 1/10,000 seconds
sssss.ss.....	speed from 0.00 to 99999.99
GR.....	group (from 01 to 99, no groups = 00)
##.....	parallel slalom net: consecutive number at each lap
(CR).....	carriage return

The following characters can be at 1st position:

x.....	blank
?.....	time without valid start number
m.....	time from memory
c.....	times cleared (with <CLEAR>)
d.....	times deleted by disqualification
i.....	time entered manually with <INPUT>
n.....	new start number shown on finish display (6)
p.....	time calculated from penalty time (parallel slalom)

Plug assignment: see chapter 8.1.5

cable from TdC 8001 to PC (9-pin) 067-02
 cable from TdC 8001 to PC (25-pin) 066-03

In the mainmenu the following can be set:

RS232 Baud rate: **menu 17** **Default = 9600 Bd**

Set baud rate for RS232 interface (d) on 2400, 4800, 9600 or 19200 baud.

Menu 17: RS232 BAUD RATE	2400 Bd	F1
	4800 Bd	F2
	9600 Bd<	F3
	19200 Bd	F4

RS232 Run time **menu 18** **Default = OFF**

In difference time mode the stopped times of day are always output via the RS232 interface (d). In addition the run times can be sent.

Menu 18: RS232 RUN TIME	EIN	F1 run time and time of day output
	AUS <	F2 only time of day output
Save with: ENTER		confirm with <ENTER>

8.2.1 Inquiry of Device Settings via RS232 Interface

Precision

RS232 inquiry	PRE?	
TdC 8001 response	PRE = 1 s	precision seconds
	PRE = 1/10 s	precision tenth of a second
	PRE = 1/100 s	precision hundredth of a second
	PRE = 1/1000 s	precision thousandth of a second

Timing mode

RS232 inquiry	TI=?	
TdC 8001 response	TI = DIFFERENC	difference timing
	TI = ABSOLUT	absolute timing

Laps at split sequential

RS232 inquiry	LAPS =?	
TdC 8001 response	LAPS = 4	set number of laps (1-99)

8.2.2 Settings of Main Menu via RS232 Interface

Delay time start..... menu 1 RS232 inquiry DTS? RS232 command..... DTS=0.30 adjustable 0.00 – 9.99 sec Delay time finish menu 2 RS232 inquiry DTF? RS232 command..... DTF=0.30 adjustable 0.00 – 9.99 sec Seconds mode menu 3 RS232 inquiry SM? RS232 command..... SM=ON adjustable ON or OFF Display time 1 menu 4 RS232 inquiry DIT1? RS232 command..... DIT1=03 adjustable 0 – 99 seconds Display time 2 menu 5 RS232 inquiry DIT2? RS232 command..... DIT2=03 adjustable 0 – 99 seconds Display thousandth menu 6 RS232 inquiry DI1/1000?	RS232 command..... DI1/1000=ON adjustable ON or OFF Info Display menu 7 RS232 inquiry IDIS? RS232 command..... IDIS=START adjustable START, FINISH, OFF Running time menu 8 RS232 inquiry RT? RS232 command..... RT=RUN adjustable RUN or TOTAL Running tenth menu 9 RS232 inquiry R1/10? RS232 command..... R1/10=OFF adjustable ON or OFF Intermediate time rank menu 10 RS232 inquiry RNKIT? RS232 command..... RNKIT=ON adjustable Run time rank menu 11 RS232 inquiry RNKFT? RS232 command..... RNKFT=ON adjustable ON or OFF
--	--

Start number automatic	menu 12	RS232 inquiry.....	STNOA?	RS232 command.....	STNOA=OFF	adjustable	ON or OFF	Automatic time	menu 13	RS232 inquiry.....	AT?	RS232 command.....	AT=XX:XX:XX.XX	adjustable	time in hrs/min/sec/1/100	Print start time	menu 14	RS232 inquiry.....	PST?	RS232 command.....	PST=OFF	adjustable	ON or OFF	Print menu	menu 15	RS232 inquiry.....	PM?	RS232 command.....	PM=ON	adjustable	ON or OFF	Paperfeed	menu 16	RS232 inquiry.....	PLF?	RS232 command.....	PLF=ON	adjustable	ON or OFF	RS232 Baud rate	menu 17	RS232 inquiry.....	mDRS?	RS232 command.....	BDRS=9600	adjustable	2400, 4800, 9600 Baud	RS 232 Run time	menu 18	RS232 inquiry.....	RSRT?	RS232 command.....	RSRT=OFF	adjustable	ON or OFF	Display board baud rate	menu 19	RS232 inquiry.....	BDDB?	RS232 command.....	2400 baud possible	adjustable	2400 baud possible	Display board channel 2	menu 20	RS232 inquiry.....	DBC2?	RS232 command.....	DBC2=RUNNING	adjustable	RUNNING, STANDING	Beep	menu 21	RS232 inquiry.....	BEEP?	RS232 command.....	BEEP=ON	adjustable	ON or OFF	Handicap time	menu 22	RS232 inquiry.....	HT?	RS232 command.....	HT=00:01:12.34	adjustable	time on 1/100, OFF=0	Input of groups	menu 23	RS232 inquiry.....	not possible	RS232 command.....	not possible	adjustable		Change heat	menu 24	RS232 inquiry.....	not possible	RS232 command.....	not possible	adjustable		Change race	menu 25	RS232 inquiry.....	not possible	RS232 command.....	not possible	adjustable		Display board test	menu 26	RS232 inquiry.....	not possible	RS232 command.....	not possible	adjustable		ID channel 4	menu 27	RS232 inquiry.....	IDC4?	RS232 command.....	IDC=BLUE	adjustable	B or L (blue or left)	Penalty time	menu 28	RS232 inquiry.....	PT?	RS232 command.....	PT=1.500	adjustable	sec and 1/1000 sec	Start channel for dual timer	menu 29	RS232 inquiry.....	STS?	RS232 command.....	STS=SEPARATE	adjustable	SEPARATE, COMMON	Rank calculation	menu 30	RS232 inquiry.....	RNKC?	RS232 command.....	RNKC=SEPARATE	adjustable	SEPARATE, COMMON	Print times	menu 31	RS232 inquiry.....	PRT?	RS232 command.....	PRT=OFF	adjustable	OFF or ON	Measuring distance	menu 32	RS232 inquiry.....	DST?	RS232 command.....	DST=0100	adjustable	1 – 9999	Measuring unit	menu 33	RS232 inquiry.....	SPU?	RS232 command.....	SPU=kmh	adjustable	kmh, m/s or mph	Minimum speed	menu 34	RS232 inquiry.....	MINSP?	RS232 command.....	MINSP=0010	adjustable	1 – 9999	Maximum speed	menu 35	RS232 inquiry.....	MAXSP?	RS232 command.....	MAXSP=0200	adjustable	1 – 9999	Penalty points	menu 36	RS232 inquiry.....	PP?	RS232 command.....	PP=04.00	adjustable	0.1 – 99.99	Exceeding time limit 1	Menu 37	RS232 inquiry.....	TV1?	RS232 command.....	TV1=00.25	adjustable	0 – 99.99	Exceeding time limit 2	menu 38	RS232 inquiry.....	TV2?	RS232 command.....	TV2=01.00	adjustable	0 – 99.99	Heat time 1	menu 39	RS232 inquiry.....	PAT1?	RS232 command.....	PAT1=000.00	adjustable	0 – 999.99	Heat time 2	menu 40	RS232 inquiry.....	PAT2?	RS232 command.....	PAT2=000.00	adjustable	0 – 999.99	Block time 1	menu 41	RS232 inquiry.....	BT1?	RS232 command.....	BT1=000.00	adjustable	0 – 999.99	Block time 2	menu 42	RS232 inquiry.....	BT2?	RS232 command.....	BT2=000.00	adjustable	0 – 999.99	Countdown time	menu 43	RS232 inquiry.....	CDT?	RS232 command.....	CDT=00:01:00.00	adjustable	0 - 23:59:59.99	D-Board countdown	menu 45	RS232 inquiry.....	DBCD?	RS232 command.....	DBCD=ON	adjustable	ON or OFF
-------------------------------------	----------------	--------------------	--------	--------------------	-----------	------------------	-----------	-----------------------------	----------------	--------------------	-----	--------------------	----------------	------------------	---------------------------	-------------------------------	----------------	--------------------	------	--------------------	---------	------------------	-----------	-------------------------	----------------	--------------------	-----	--------------------	-------	------------------	-----------	------------------------	----------------	--------------------	------	--------------------	--------	------------------	-----------	------------------------------	----------------	--------------------	-------	--------------------	-----------	------------------	-----------------------	------------------------------	----------------	--------------------	-------	--------------------	----------	------------------	-----------	--------------------------------------	----------------	--------------------	-------	--------------------	--------------------	------------------	--------------------	--------------------------------------	----------------	--------------------	-------	--------------------	--------------	------------------	-------------------	-------------------	----------------	--------------------	-------	--------------------	---------	------------------	-----------	----------------------------	----------------	--------------------	-----	--------------------	----------------	------------------	----------------------	------------------------------	----------------	--------------------	--------------	--------------------	--------------	------------------	--	--------------------------	----------------	--------------------	--------------	--------------------	--------------	------------------	--	--------------------------	----------------	--------------------	--------------	--------------------	--------------	------------------	--	---------------------------------	----------------	--------------------	--------------	--------------------	--------------	------------------	--	---------------------------	----------------	--------------------	-------	--------------------	----------	------------------	-----------------------	---------------------------	----------------	--------------------	-----	--------------------	----------	------------------	--------------------	---	----------------	--------------------	------	--------------------	--------------	------------------	------------------	-------------------------------	----------------	--------------------	-------	--------------------	---------------	------------------	------------------	--------------------------	----------------	--------------------	------	--------------------	---------	------------------	-----------	---------------------------------	----------------	--------------------	------	--------------------	----------	------------------	----------	-----------------------------	----------------	--------------------	------	--------------------	---------	------------------	-----------------	----------------------------	----------------	--------------------	--------	--------------------	------------	------------------	----------	----------------------------	----------------	--------------------	--------	--------------------	------------	------------------	----------	-----------------------------	----------------	--------------------	-----	--------------------	----------	------------------	-------------	-------------------------------------	----------------	--------------------	------	--------------------	-----------	------------------	-----------	-------------------------------------	----------------	--------------------	------	--------------------	-----------	------------------	-----------	--------------------------	----------------	--------------------	-------	--------------------	-------------	------------------	------------	--------------------------	----------------	--------------------	-------	--------------------	-------------	------------------	------------	---------------------------	----------------	--------------------	------	--------------------	------------	------------------	------------	---------------------------	----------------	--------------------	------	--------------------	------------	------------------	------------	-----------------------------	----------------	--------------------	------	--------------------	-----------------	------------------	-----------------	--------------------------------	----------------	--------------------	-------	--------------------	---------	------------------	-----------

8.2.3 Retrieve Data via RS232 Interface

All data of the TdC 8001 memory can be retrieved via RS232 Interface by for example a PC. Every input via the RS232 interface is confirmed with carriage return (in the following abbreviated (CR)). If a ranking of intermediate times is required, always all channel numbers must be entered.

If a "SINGLE" ranking is required, the data to be retrieve must be entered after the command line (e. g. start numbers, start number blocks, groups).

Ranking „NOT FINISHED“	NOF(CR)	all competitors that did not reach the finish
Ranking „DISQUALIFIED“	DIS(CR)	all disqualified competitors
Ranking „START ORDER“	STO(CR)	start order for 2 nd heat (BIBO)

Ranking

„ALL“ ----- total ranking of ...

CALRT(CR) ----- run time
 CAL01RT(CR) ----- run time of lap (01 = lap 1)
 CAL01SQ(CR) ----- lap time (01 = lap 1)
 CALMT(CR) ----- memory time
 CALTT(CR) ----- total time
 CALITC2(CR) ----- intermediate time of channel C2
 CALITC3(CR) ----- intermediate time of channel C3
 CALITC4(CR) ----- intermediate time of channel C4
 CALITC5(CR) ----- intermediate time of channel C5
 CALITC6(CR) ----- intermediate time of channel C6
 CALITC7(CR) ----- intermediate time of channel C7
 CALITC8(CR) ----- intermediate time of channel C8
 CALITC9(CR) ----- intermediate time of channel C9
 CALBRT(CR) ----- run time of all competitors of blue course (dual timer)
 CALRRT(CR) ----- run time of all competitors of red course (dual timer)
 CALLRT(CR) ----- run time of all competitors of left course (dual timer)

„GROUP“ „ALL“ ----- group ranking of ...

Enter groups. Every group must be entered with two digits and confirmed with CR. Termination: 00 and CR

CGRALRT(CR) ----- run time of all groups
 CGRALMT(CR) ----- memory time of all groups
 CGRALTT(CR) ----- total time of all groups
 CGRALITC2(CR) ----- intermediate time channel C2 of all groups
 CGRALITC3(CR) ----- intermediate time channel C3 of all groups
 CGRALITC4(CR) ----- intermediate time channel C4 of all groups
 CGRALITC5(CR) ----- intermediate time channel C5 of all groups
 CGRALITC6(CR) ----- intermediate time channel C6 of all groups
 CGRALITC7(CR) ----- intermediate time channel C7 of all groups
 CGRALITC8(CR) ----- intermediate time channel C8 of all groups
 CGRALITC9(CR) ----- intermediate time channel C9 of all groups
 CGRALBRT(CR) ----- run time of all groups of blue course (dual timer)
 CGRALRRT(CR) ----- run time of all groups of red (right) course (dual timer)
 CGRALLRT(CR) ----- run time of all groups of left course (dual timer)

„GROUP“ „SINGLE“ ----- single ranking of ...

CGRSIRT(CR) ----- run time of selected groups
 CGRSIMT(CR) ----- memory time of selected groups
 CGRSITT(CR) ----- total time of selected groups
 CGRSIITC2(CR) ----- intermediate time C2 of selected groups
 CGRSIITC3(CR) ----- intermediate time C3 of selected groups
 CGRSIITC4(CR) ----- intermediate time C4 of selected groups
 CGRSIITC5(CR) ----- intermediate time C5 of selected groups
 CGRSIITC6(CR) ----- intermediate time C6 of selected groups
 CGRSIITC7(CR) ----- intermediate time C7 of selected groups
 CGRSIITC8(CR) ----- intermediate time C8 of selected groups
 CGRSIITC9(CR) ----- intermediate time C9 of selected groups
 CGRSIBRT(CR) ----- run time of individual groups of blue course (dual timer)
 CGRSIRRT(CR) ----- run time of individual groups of red course (dual timer)
 CGRSILRT(CR) ----- run time of individual groups of left course (dual timer)
 01(CR) ----- e. g. group 1
 04(CR) ----- e. g. group 4
 07(CR) ----- e. g. group 7
 00(CR) ----- termination of this input

„CLASS“ ----- ranking of ...

A class can be composed of several start number blocks. Every start number block gives the first and last start number of the block. Start numbers are separated by hyphen. Confirm every block with CR. Termination: 0000-0000 and CR.

CCLRT(CR)----- run time of start number blocks (classes)
 CCL01RT(CR) ----- run time of lap (01=lap 1) of start number blocks
 CCL01SQ(CR)----- lap time (01=lap 1) of start number blocks
 CCLMT(CR) ----- memory time of start number blocks (classes)
 CCLTT(CR) ----- total time of start number blocks (classes)
 CCLITC2(CR) ----- intermediate time C2 of start number blocks (classes)
 CCLITC3(CR) ----- intermediate time C3 of start number blocks (classes)
 CCLITC4(CR) ----- intermediate time C4 of start number blocks (classes)
 CCLITC5(CR) ----- intermediate time C5 of start number blocks (classes)
 CCLITC6(CR) ----- intermediate time C6 of start number blocks (classes)
 CCLITC7(CR) ----- intermediate time C7 of start number blocks (classes)
 CCLITC8(CR) ----- intermediate time C8 of start number blocks (classes)
 CCLITC9(CR) ----- intermediate time C9 of start number blocks (classes)
 CCLBRT(CR)----- run time of start number blocks of blue course (dual timer)
 CCLRRT(CR) ----- run time of start number blocks red (right) course (dual timer)
 CCLLRT(CR)----- run time of start number blocks left course (dual timer)
 0001-0024(CR) ----- input start number block e.g. stno 1 - 24
 0065-0073(CR) ----- input start number block e.g. stno 65 - 73
 0105-0124(CR) ----- input start number block e.g. stno 105 – 124
 0000-0000(CR) ----- termination of this input

„FIRST TEN“ ----- ranking of ...

CFTRT(CR)----- run time of first ten competitors
 CFT01RT(CR) ----- run time of lap (01=lap 1) of first ten competitors
 CFT01SQ(CR)----- Randenzzeit (01=Rande 1) of first ten competitors
 DFTMT(CR) ----- memory time of first ten competitors
 DFTTT(CR) ----- total time of first ten competitors
 CFTITC2(CR) ----- intermediate time C2 of first ten competitors
 CFTITC3(CR) ----- intermediate time C3 of first ten competitors
 CFTITC4(CR) ----- intermediate time C4 of first ten competitors
 CFTITC5(CR) ----- intermediate time C5 of first ten competitors
 CFTITC6(CR) ----- intermediate time C6 of first ten competitors
 CFTITC7(CR) ----- intermediate time C7 of first ten competitors
 CFTITC8(CR) ----- intermediate time C8 of first ten competitors
 CFTITC9(CR) ----- intermediate time C9 of first ten competitors
 CFTBRT(CR)----- run time of first ten blue course (dual timer)
 CFTRRT(CR)----- run time of first ten red (right) course (dual timer)
 CFTLRT(CR)----- run time of first ten left course (dual timer)

„SINGLE“ ----- ranking of ...

Enter start numbers for ranking. Every start number must be four-digit and confirmed with CR. Termination: 0000 and CR

CSIRT(CR)----- run time of single start numbers
 CSI01RT(CR) ----- run time of lap (01=lap 1) of single start numbers
 CSI01SQ(CR)----- lap time (01=lap 1) of single start numbers
 CSIMT(CR) ----- memory time of single start numbers
 CSITT(CR) ----- total time of single start numbers
 0001(CR)----- input first start number
 0005(CR)----- input further start numbers
 0012(CR)----- input further start numbers
 0000(CR)----- termination of input

„ADDING“ ----- adding of ... of start numbers

Enter start numbers for addition; start numbers must be four-digit; confirm with CR. Termination: 000 and CR.

CADRT(CR)----- run time
 CAD01RT(CR) ----- run time of lap (01=lap 1)
 CAD01SQ(CR)----- lap time (01=lap 1)
 CADMT(CR) ----- memory time
 CADTT(CR)----- total time
 CADITC2(CR)----- intermediate time C2
 CADITC3(CR)----- intermediate time C3
 CADITC4(CR)----- intermediate time C4
 CADITC5(CR)----- intermediate time C5
 CADITC6(CR)----- intermediate time C6

CADITC7(CR)----- intermediate time C7
 CADITC8(CR)----- intermediate time C8
 CADITC9(CR)----- intermediate time C9
 0001(CR)----- input first start number
 0005(CR)----- input further start number
 0012(CR)----- input further start number
 0025(CR)----- input last start number
 0000(CR)----- termination of input

„PROTOCOL“ and „ALL“ ----- protocol of all
 PALST(CR) ----- start times
 PALFT(CR) ----- finish times
 PALRT(CR) ----- run times
 PALSQ(CR)----- sequential times (lap times)
 PALMT(CR)----- memory times
 PALTT(CR)----- total times
 PALITC2(CR)----- intermediate times channel C2
 PALITC3(CR)----- intermediate times channel C3
 PALITC4(CR)----- intermediate times channel C4
 PALITC5(CR)----- intermediate times channel C5
 PALITC6(CR)----- intermediate times channel C6
 PALITC7(CR)----- intermediate times channel C7
 PALITC8(CR)----- intermediate times channel C8
 PALITC9(CR)----- intermediate times channel C9
 PALBRT(CR) ----- run times blue course (dual timer)
 PALRRT(CR) ----- run times red (right) course (dual timer)
 PALLRT(CR) ----- run times left course (dual timer)

„PROTOCOL“ and „SINGLE“ ----- protocol of selected ...

Enter start number blocks. The protocol can be composed of several start number blocks. Confirm every block with CR. Termination. 000-000 and CR.

PSIST(CR)----- start times
 PSIFT(CR) ----- finish times
 PSIRT(CR)----- run times
 PSISQ(CR) ----- sequential times (lap times)
 PSIMT(CR) ----- memory times
 PSITT(CR) ----- total times
 PSIITC2(CR) ----- intermediate times channel C2
 PSIITC3(CR) ----- intermediate times channel C3
 PSIITC4(CR) ----- intermediate times channel C4
 PSIITC5(CR) ----- intermediate times channel C5
 PSIITC6(CR) ----- intermediate times channel C6
 PSIITC7(CR) ----- intermediate times channel C7
 PSIITC8(CR) ----- intermediate times channel C8
 PSIITC9(CR) ----- intermediate times channel C9
 PSIBRT(CR)----- run times blue course (dual timer)
 PSIRRT(CR)----- run times red (right) course (dual timer)
 PSILRT(CR) ----- run times left course (dual timer)
 0001-0024(CR) ----- input start number blocks
 0065-0073(CR) ----- input start number blocks
 0105-0124(CR) ----- input start number blocks
 0000-0000(CR) ----- termination of input

8.3 RS485 Interface (a,d)

Transfer rate: 60 kBaud
Plug assignment: see chapter 8.2

8.4 Display Board (e) – Interface for Display Board

Output format: 1 start bit, 8 data bit, no parity bit, 1 stop bit
Transfer rate: standard 2,400 baud (adjustable 4800, 9600, 19200)
Transfer protocol: ASCII

The display board interface has two different channels

channel 1: running time

channel 2: running time and ranking or stopped time and ranking

Attention: Channels 1 and 2 can be switched by turning the plug at jack (e) by 180°.

Output at channel 1 is always the same as shown on displays (7) and (8). The set display times (menu4) apply for display (7) and (8) as well as for channel 1 of the display board interface (e). No ranking is sent.

In channel 2 of the main menu (menu 20) can be switched between running and stopped time. The ranking is always transferred at channel 2.

NNN . xxxxxxxxM : SSxxxx (CR)	running time (without 1/10 seconds)
NNN . xxxxxHH . MM . SSxxxx (CR)	running time (without 1/10 seconds)
NNN . xxxxxHH : MM : SS . zxx (CR)	running time (with 1/10 seconds)
NNNCxxxxHH : MM : SS . zhtRR (CR)	channel C1 finish time with rank
NNNCxxxxHH : MM : SS . zhtxx (CR)	channel C1 finish time without rank
NNNDxxxxHH : MM : SS . zhtRR (CR)	channel C1 total time with rank
NNNDxxxxHH : MM : SS . zhtxx (CR)	channel C1 total time without rank
NNNAxxxxHH : MM : SS . zhtRR (CR)	channel C2 1 st intermediate time
NNNBxxxxHH : MM : SS . zhtRR (CR)	channel C3 2 nd intermediate time
NNNExxxxHH : MM : SS . zhtRR (CR)	channel C4 3 rd intermediate time
NNNFxxxxHH : MM : SS . zhtRR (CR)	channel C5 4 th intermediate time
NNNGxxxxHH : MM : SS . zhtRR (CR)	channel C6 5 th intermediate time
NNNHxxxxHH : MM : SS . zhtRR (CR)	channel C7 6 th intermediate time
NNNIxxxxHH : MM : SS . zhtRR (CR)	channel C8 7 th intermediate time
NNNJxxxxHH : MM : SS . zhtRR (CR)	channel C9 8 th intermediate time
NNNSxxx©xxxxsxs . sxxRR (CR)	speed
ANNxxxxxHH : MM : SS . zhtRR (CR)	sequential time for program split sequential

NNN start number (hundreds, tens and units, digits 1 to 3)

..... dot on the fourth digit is the identification for a running time

A,B,C ...,H,I,J address for display board (digit 1)

A,B,C, ...,H,I,J identification of channel (4th digit)

© speed measurement: output fo following ASCII characters:

01 hex for km/h, 02 hex for m/s, 03 hex for mph

RR rank

x blank

(CR) carriage return

Plug assignment: see

cable from TdC 8001 to display board GAZ5: 010-10

cable from TdC 8001 to Teledata TED-TX with power supply: 107-10

In the main menua the following setting can be made for this interface

D-Board time 1

Menu 4

Default = 3 seconds

A time can be set that indicates for how long a stopped time (e. g. intermediate time, run time) remains on display (5) and display board before the running time is shown once again. This time is called display time 1. It can be set between 0 and 99 seconds.

Menu 4: DISPLAY TIME 1 = 03 S

enter seconds with finish keypad (8)

Save with: ENTER

exit with <ENTER>

D-Board time 2

Menu 5

Default = 3 seconds

A time can be set that indicates for how long the second time in second heat (total time or run time) remains on the display (5) and the display board before the ranking disappears (or switches back to total time). This time is called display time 2. It can be set between 0 and 99 seconds.

Menu 4: DISPLAY TIME 2 = 03 S

enter seconds with finish keypad (8)

Save with: ENTER

exit with <ENTER>

Display board baud rate

Menu 19

Default = 2400 Bd

The display board interface can be set to 2400, 4800, 9600 or 19200 baud. When using ALGE display board 2400 baud must be set.

Menu 19: RS232 BAUD RATE 2400 Bd <

F1

4800 Bd

F2

9600 Bd

F3

19200 Bd

F4

Save with: ENTER

D-Board channel 2

Menu 20

Default = running

The output can be set at channel 2 of interface display board (e). Output of running time, stopped time or best time is possible. A ranking is always output via the display board interface (e) at channel 2.

TdC 8001 sold from 2008:

Pin 1 of DIN plug "display board" (e) is switched over. Banana jack always receive running time.

TdC 8001 sold before 2008:

Switching between channel 1 and 2 can be effected by turning the plug by 180°. Pin 3 receives always the running time; Pin 3 can be switched over in menu 19. Banana jack is also switchable.

Menu 4: D-BOARD CHANNEL 2 RUNNING <

F1 output of stopped time

STOPPED

F2 output of running time

BEST TIME

F3 output of best time

Save with: ENTER

confirm with <ENTER>

Brightness of LED display board

Menu 55

Default = 9

When an ALGE LED display board is used, the brightness can be adjusted in 10 steps.

Menu 55: LED BRIGHTNESS = 9

input between 0 and 9

0 = dark, 9 = bright

Save with: ENTER

exit with <ENTER>

Subject to changes

Copyright by

ALGE-TIMING GmbH
Rotkreuzstr. 39
6890 Lustenau / Austria
www.alge-timing.com