

ALGE-TIMING

Timing 2



Manual
General

Important Information

General

Before using your **ALGE-TIMING** device read the complete manual carefully. It is part of the device and contains important information about installation, safety and its intended use. This manual cannot cover all conceivable applications. For further information or in case of problems that are mentioned not at all or not sufficiently detailed, please contact your **ALGE-TIMING** representative. You can find contact details on our homepage www.alge-timing.com

Safety

Apart from the information of this manual all general safety and accident prevention regulations of the legislator must be taken into account.

The device must only be used by trained persons. The setting-up and installation must only be executed according to the manufacturer's data.

Intended Use

The device must only be used for its intended applications. Technical modifications and any misuse are prohibited because of the risks involved! **ALGE-TIMING** is not liable for damages that are caused by improper use or incorrect operation.

Power supply

The stated voltage on the type plate must correspond to voltage of the power source. Check all connections and plugs before usage. Damaged connection wires must be replaced immediately by an authorized electrician. The device must only be connected to an electric supply that has been installed by an electrician according to IEC 60364-1. Never touch the mains plug with wet hands! Never touch live parts!

Cleaning

Please clean the outside of the device only with a smooth cloth. Detergents can cause damage. Never submerge in water, never open or clean with wet cloth. The cleaning must not be carried out by hose or high-pressure (risk of short circuits or other damage).

Liability Limitations

All technical information, data and information for installation and operation correspond to the latest status at time of printing and are made in all conscience considering our past experience and knowledge. Information, pictures and description do not entitle to base any claims. The manufacturer is not liable for damage due to failure to observe the manual, improper use, incorrect repairs, technical modifications, use of unauthorized spare parts. Translations are made in all conscience. We assume no liability for translation mistakes, even if the translation is carried out by us or on our behalf.

Disposal

If a label is placed on the device showing a crossed out dustbin on wheels (see drawing), the European directive 2002/96/EG applies for this device.

Please get informed about the applicable regulations for separate collection of electrical and electronical waste in your country and do not dispose of the old devices as household waste. Correct disposal of old equipment protects the environment and humans against negative consequences!



Copyright by **ALGE-TIMING GmbH**

All rights reserved. Any duplication, either in full or in part, requires the prior written consent of the copyright holder.

Declaration of Conformity

We declare that the following products comply with the requirements of the listed standards.

We, **ALGE-TIMING GmbH**
Rotkreuzstrasse 39
A-6890 Lustenau

declare under our sole responsibility, that the timing device

Timy2 XE and Timy2 PXE

•
is in conformity with the following standard(s) or other normative documents(s):

Safety: EN 60950-1:2006 + A11:2009

EMC: EN55022:2006+A1:2007
EN55024:1998+A1:2001+A2:2003
EN61000 3-2:2006 + A1:2009 + A2:2009
EN61000 3-3:2008

Additional Information:

The product herewith complies with the requirements of the Low Voltage Directive 73/23/EEC, also the EMC Directive 2004/108EG and accordingly carries the CE-marking.

Lustenau, 20.10.2010

ALGE-TIMING GmbH



Albert Vetter
(General Manager)

Control elements

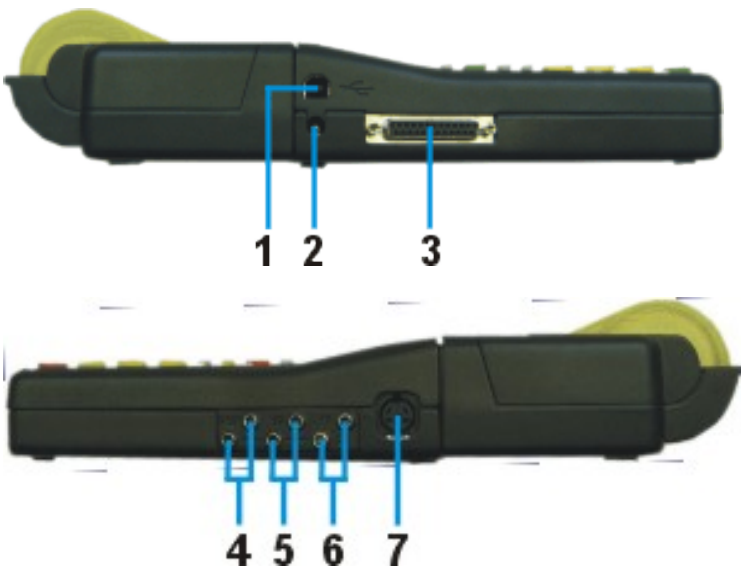

- 1 USB-interface
- 2 Charging socket
- 3 ALGE multiport
- 4 Connection for displayboard
- 5 Connection for start emitter (C0)
- 6 Connection for finish emitter (C1)
- 7 Standard ALGE photocell socket

Table of contents

1	Device Description	7
1.1	TIMY2 Models	7
1.2	TIMY2 Software	8
1.3	Driver Installation	8
1.4	Keypad.....	9
1.5	Display of TIMY2.....	10
1.6	Choose Language.....	11
2	Start Up	12
2.1	Switch On	12
2.2	Switch Off	12
2.3	Power Supply.....	12
3	Printer	14
3.1	Change of Paper.....	14
4	Synchronising	14
4.1	Synchronisation of Other Devices with a TIMY2:.....	14
5	Connection of Auxiliary Devices.....	15
5.1	Channels.....	15
5.2	Delay and Block Times.....	15
5.2.1	Delay Time.....	15
5.2.2	Block Time.....	15
5.3	Diagram of Delay and Block Time	15
6	TIMY2 Update	16
6.1	Update with Cable 205-02.....	16
6.2	Update with USB Cable.....	17
7	Memory	17
8	Info Mode	18
9	GPS Synchronisation.....	18
10	Menu.....	19
10.1	CLASSEMENT	19
10.1.1	ALL	19
10.1.2	CLASS.....	19
10.1.3	START LIST	19
10.2	GENERAL.....	19
10.2.1	PREC-ROUNDING	19
10.2.2	CHANGE HEAT	20
10.2.3	STN-AUTOMATIC	20
10.2.4	SEC-MODE	20
10.2.5	LANGUAGE.....	21
10.2.6	STANDARD	21
10.2.7	HARDWARE.....	21
10.2.8	HARDWARE 2.....	21
10.2.9	PROGS ON OFF	21
10.3	CHANNELS	21
10.3.1	INTERNAL.....	21
10.3.2	BEEP	22
10.3.3	TED-RX	22
10.3.4	CHANNEL-PATTERN.....	22
10.4	DISPLAY	22
10.4.1	RUNNING TENTH.....	22
10.4.2	DELAYTIME 1	22
10.4.3	DELAYTIME 2	22
10.4.4	BACK LIGHT	22

10.5	INTERFACE.....	23
10.5.1	DISPLAYBOARD.....	23
10.5.2	RS-232.....	23
10.5.3	GSM-MODEM.....	23
10.6	PRINTER.....	24
10.6.1	PRINTER-MODE.....	24
10.6.2	PRINT STARTTIME.....	24
10.6.3	AUTO LINE FEED.....	24
10.6.4	START-LOGO.....	24
10.6.5	PRINT DAYTIME.....	24
10.7	PROGRAM.....	24
10.8	Program Specific Settings.....	24
10.9	KEYBOARD-LOCK.....	24
11	Technical data.....	25
11.1	Pin assignment.....	26
12	Interfaces.....	28
12.1	RS232 Interface.....	28
m 0009 c0	15:44:00,5499 00.....	28
n 0014 c0	15:44:01,0366 00.....	28
12.2	RS485 Interface.....	31
12.3	Interface for displayboard.....	31
13	USB Interface.....	31

1 Device Description

The **ALGE TIMY2** is a handy device, equipped with high-quality technology.

During the development, we have paid special attention to the self-evident principles of **ALGE-TIMING**: ease of operation, extreme reliability and robust design. Latest technology, integrated in a casing especially designed for timing, result in a unique device.

In spite of the handy dimensions, the TIMY2 provides a large and easy-to-use silicone keypad. It can be operated easily in any weather condition and even with gloves. The model TIMY2 PXE has an integrated printer that records the entire competition.

Of course, the TIMY2 is also equipped with the necessary interfaces for communication with external devices. It possesses an interface for display boards, an RS232 interface for communication with a computer, an RS485 interface to establish a network of timing devices and a future-proof USB interface.

The generously dimensioned memory of the TIMY2 can store up to 30 000 times. All memory times can be shown on the display or transmitted to a computer by RS 232 or USB interface at any time.

1.1 TIMY2 Models

TIMY2 XE:

TIMY2 XE is a timing device without printer. Equipped with a temperature compensated quartz-oscillator, it performs timing tasks with highest accuracy. The extended temperature range enables using the TIMY2 up to -20° C (for summer and winter sports).



TIMY2 PXE:

TIMY2 PXE is a timing device with integrated printer. Provided with a temperature compensated quartz-oscillator, it will perform timing tasks with highest accuracy. The extended temperature range enables using the TIMY2 up to -20° C (for summer and winter sports).



1.2 TIMY2 Software

Available programs for the TIMY2 :

- Stopwatch:** universal timing program which is suitable for several heats (run/total time).
- Backup:** to measure time-of-day times (e. g. as backup-system or as time reference for the computer)
- PC-Timer:** to measure time-of-day times with simultaneous output of the running time in 1/10 seconds via the RS232 interface. Ideal as an accurate timing device for the computer
- LapTimer:** timing program with run times and lap times (e. g. for motor sport)
- TrackTimer:** timing program for events with several lanes, e. g. athletics and swimming
- Training Light:** universal training software (several intermediate times are possible)
- Training REF:** training software with reference run (several competitors on course)
- Speed:** speed measurement
- Commander:** terminal for diverse subprograms (see manual)
- CycleStart:** program for track cycling with countdown and lap counter
- Terminal:** terminal for judges (e. g. gymnastics)
- Wind Speed:** for measuring the wind speed, only with anemometer WS2
- Parallel-Diff:** timing for parallel slalom (difference time of both slopes)
- Dual Timer:** timing of two separate courses
- Timeout:** timing with timeout, also applicable for show jumping (with start countdown)
- Swim Trainer:** training program for swimming
- Jumping:** training program for jump trials, measures jumping height on the basis of time between jump and landing on a contact mat (several subprograms)
- Speed-Climbing:** Timing for parallel competitions at speed climbing with false start

1.3 Driver Installation

For installation of drivers, separate manuals are available. You can download them on our homepage www.alge-timing.com or contact your **ALGE** representative.

1.4 Keypad

The TIMY2 has a weather-proof (water-proof) silicone keypad. The keypad is ideal for outdoor use. The keys are raised and have ideal pressure points. Although the TIMY2 is small in dimensions, they are easy to operate.

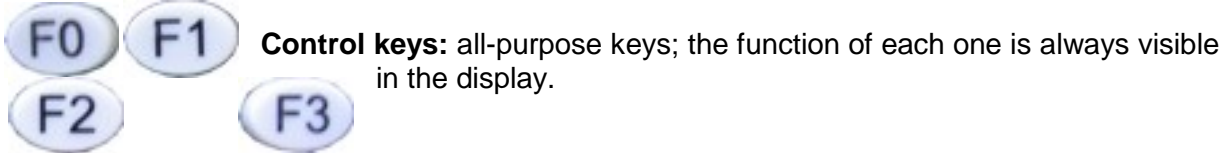



START/ON: Key for manual start impulse and to switch on the TIMY2.



STOP/OFF: Key for manual stop impulse and to switch off the TIMY.



Printer: Key for paper output. If you press the combination  and , you open the printer menu.



2nd: This key is always used in combination with a second key (additional function).



Menu: Key to enter the device menu.



CLR: Key to clear the marked times or to clear the memory.



Cursor: Keys to move the cursor in the display.



Beginning of a list

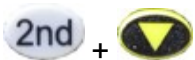

End of a list



OK green: Switch on, confirm commands or start inputs



OK red: Switch off, confirm commands or finish inputs

1.5 Display of TIMY2

The TIMY2 has a display with backlight. The backlight makes reading of the display at bad light conditions easier. As the backlight consumes energy it is only switched on automatically when the TIMY2 is connected with an external power supply (e. g. PS12A). If you use the TIMY2 in battery mode you can switch on the backlight in the menu.

- Press menu key
- Select <DISPLAY> with arrow down key
- Press OK key (red or green)
- Select <Back Light> with arrow down key
- Press OK key (red or green)



- The display shows:



ENERGY-SAVE:	External Supply:	Display Back Light on (100% brightness)
	Battery Operation:	Display Back Light off
ON:	External Supply:	Display Back Light on (100% brightness)
	Battery Operation:	Display Back Light on (50% brightness)
AUTOMATIC:	after each key stroke or timing impulse the back light is on for 5 seconds	

- Choose desired light function with arrow down key
- Press OK key (green or red)
- Exit menu by pressing menu key



1.6 Choose Language

Currently, you can choose between the following languages: German, English, French and Italian.

- Press menu key
- Select <GENERAL> or <ALLGEMEIN> with arrow down key
- Press OK-key (red or green)
- Select <LANGUAGE> or <SPRACHE> with arrow down key
- Press OK-key (red or green)



- The display shows:



Display in German



Display in English

- Select desired language with arrow down key
- Press OK key (green or red)
- Exit the menu by pressing menu-key



2 Start Up

2.1 Switch On

- Press „START/ON“ key
- Display shows:
“Really switch-on? Press the green OK button!”
- If you press the green OK key within 10 seconds, the TIMY2 switches on, otherwise it automatically switches off.



2.2 Switch Off

You have got two possibilities to switch off the TIMY2:

Method 1:

- Press „STOP/OFF“ key for 3 seconds
- Display shows:
“Really switch-off? Press the red OK button!”
- If you press the red OK key within 10 seconds, the TIMY2 switches off, otherwise it returns to the program.



Method 2:

- Press „2nd“ and „STOP/OFF“ keys
- Display shows:
“Really switch-off? Press the red OK button!”
- If you press the red OK key within 10 seconds, the TIMY2 switches off, otherwise it returns to the program.



2.3 Power Supply

The TIMY2 has several possibilities for power supply:

External supply +8 to 22 VDC:

- Power supply unit PS12
- Power supply unit PS12A , ideal as the Deltron socket remains free
- External battery e. g. 12V plumb rechargeable battery
- ALGE Display Board (e. g. GAZ4 or D-LINE)

NLG4 and **NLG8** must NOT be used as the off-load voltage is too high (TIMY2 might be destroyed!).

With external supply of at least 11.0 VDC, the internal rechargeable batteries are charged.

Internal supply:

The battery compartment has space for 6 batteries type AA or rechargeable batteries. For TIMY2 PXE you have to use the heat-sealed rechargeable battery-packs ONLY!

Timy2	Timy2 XE		Timy2 PXE	
	-20°C / -4F	20°C / 68F	-20°C / -4F	20°C / 68F
Alkaline Batteries			not possible	not possible
NiMH Rechargeable NM-TIMY2	about 50 hours	about 60 hours	about 31 hours	about 47 hours

This measurement took place without the TIMY2 supplying external devices (e. g. no supply of photocells) and for the PXE with 3 printed lines per minute.

Battery types:

Alkaline batteries: These batteries must never be used in a TIMY2 with integrated printer. Alkaline batteries can only supply about 10 % of their original capacity at temperatures of -20°C. Thus they are only recommendable for warm weather. On environmental reasons it is also recommendable that rechargeable batteries are used.

NiMH battery pack NM-TIMY2: The NiMH rechargeable battery pack is recommended for every TIMY2. These newly developed batteries dispose of an enormous persistence even at very low temperatures and can supply a high current for the printer.

Charging:

The rechargeable batteries are charged inside the TIMY2 with charger PS12 or PS12A, no matter if the TIMY2 is switched on or off. The charging period with NiMH batteries (NM-TIMY2) takes with 1.5 Ah approx. 14 hours.

Charging Switch:

The TIMY2 has got a switch (hidden behind the battery label) for switching on or off the rechargeable battery charging.

Using alkaline batteries, the charging must be switched off -position ALKALI-, as otherwise the batteries may leak.

During the operation with rechargeable batteries, the switch should be on position NiCd/NiMH so that the rechargeable batteries are charged.

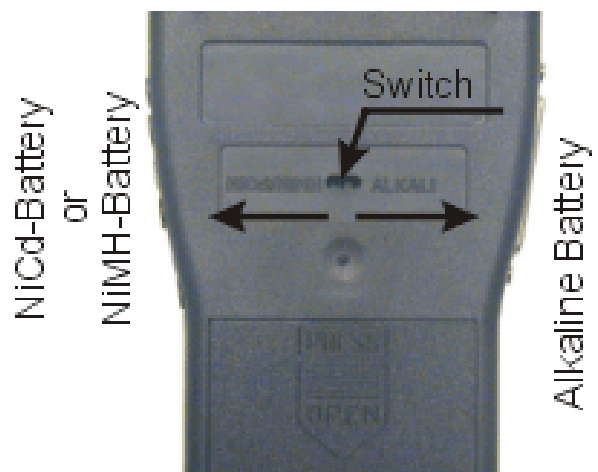

Attention: Never use alkaline batteries in a TIMY2 when the charging switch is set on NiCd/NiMH and a charger is connected.

Operating period:

The operating period depends on the TIMY2 model, the batteries utilized and the ambient temperature.

3 Printer

TIMY2 PXE has an integrated thermal printer. The best paper for the printer is our **ALGE** paper. It is recognizable by the **ALGE** logo print on the reverse side, available with your **ALGE** representative.

3.1 Change of Paper

- open printer cap
- take out the paper axis
- place the axis inside the paper roll
- insert paper roll with axis into TIMY2
- thread paper through tear-off edge
- close printer cap

4 Synchronising

- connect TIMY2 with cable 000-xx or 004-xx to other timing devices.
- switch on the TIMY2
- clear or retain memory
- retain time and date or correct it and confirm or trigger with START key or via channel C0.

4.1 Synchronisation of Other Devices with a TIMY2:

The TIMY2 can send a synchronisation signal via channel 0 every full minute when using the programs BACK-UP or PC-TIMER.

- connect the TIMY2 with the device to be synchronized
- enter the time of day (next full minute) to be synchronized at the device
- press and hold both keys, the green and red OK key of the TIMY2; on the full minute the TIMY2 sends a synchronisation impulse. The time of day of the timing device now runs.



5 Connection of Auxiliary Devices

A wide range of devices can be operated with the TIMY2. Please ask your ALGE representative for the possibilities.

5.1 Channels

The TIMY2 has 9 independent timing channels.

Attention: Channels 0 to 5 have a maximum precision of 1/10 000 seconds but channel 6 to 8 only 1/100 seconds.

5.2 Delay and Block Times

The variable delay and block times prevent generating double impulses and losing impulses. The delay and block times can be changed in the menu.

5.2.1 Delay Time

After triggering an impulse, further impulses of the same impulse channel are disabled for the duration of the delay time.

Base settings:	start channel	C0	1.0s
	stop channel	C1 to C9	0.3s

5.2.2 Block Time

The block time is the theoretic minimum interval between two valid impulses of the same channel. Impulses within the block time are saved as invalid. The block time is only supported by certain programs.

That is to say, for an interval start of 30 seconds the minimum clearance is approx. 20 seconds. Thus the block time is 20 seconds, too.

5.3 Diagram of Delay and Block Time

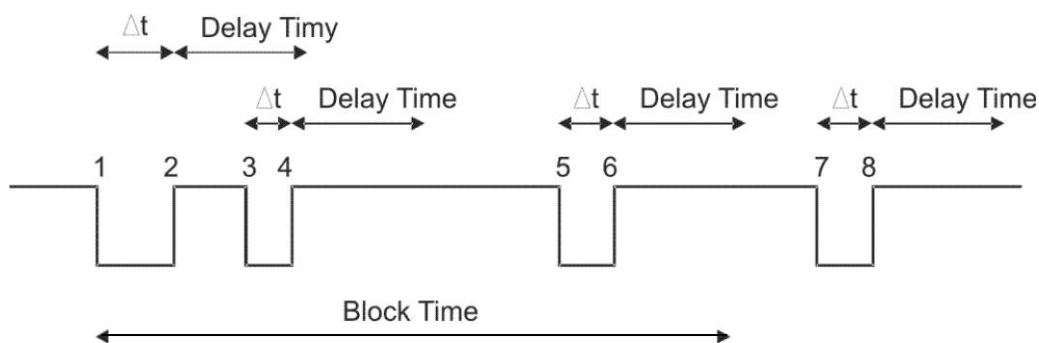

- ▲t timing channel triggered
- 1 timing channel is triggered – valid time is saved – block time starts
- 2 end of impulse – delay time starts
- 3 timing channel is triggered within the delay time – no impulse triggering
- 4 end of impulse – delay time restarts
- 5 timing channel is triggered within the block time – invalid time is saved but not printed
- 6 end of impulse – delay time starts
- 7 timing channel is triggered – valid time is saved – block time starts

6 TIMY2 Update

Please visit our homepage www.ALGE-timing.com for a free update for your TIMY2 software.

6.1 Update with Cable 205-02

- log into the internet
- choose language
- click on „download“ in the left column
- click on „ALGE devices software (Flash Technology)“
- if not installed yet, download “*Install Manager*”
- open *Install Manager* and connect TIMY2 with cable 205-02 to the computer
- click on “firmware RS232” in the *Install Manager*
- the firmware automatically searches for the TIMY2
- switch on the TIMY2
- as soon as the firmware recognizes the TIMY2, the following is displayed



- Choose a method of updating the TIMY2. Recommendable is an internet update as the latest version is always available.

6.2 Update with USB Cable

- If not yet done, the TIMY2 USB driver has to be installed. An instruction for this can be found on our homepage.
- The TIMY2 USB driver can be found at *Download/PC software/Various Software:/Timy USB and Timy2 update*
- start the *Install Manager* and click on TIMY2 USB

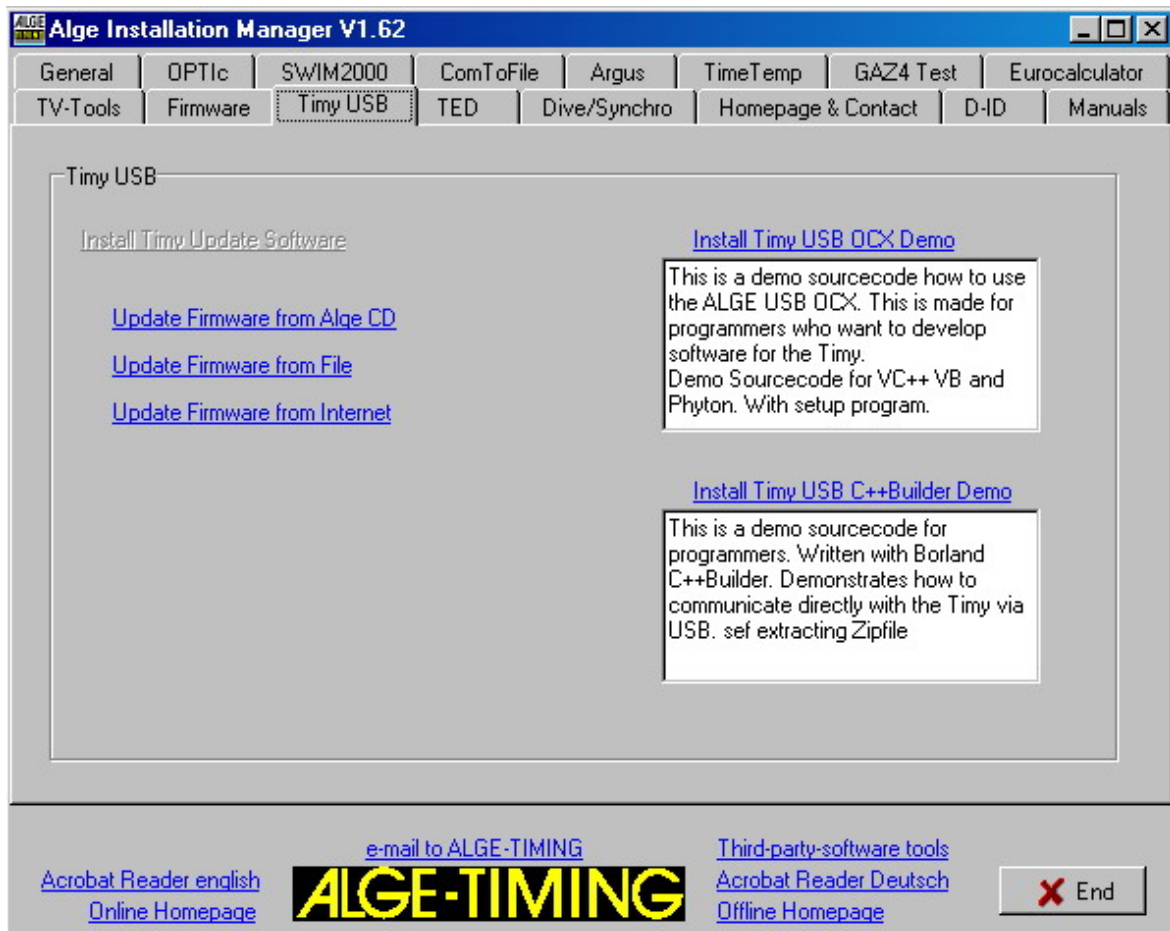

- choose method of update; details can be found at: [Manual/Timy Driver Update](#)

7 Memory

The memory of the TIMY2 can store approx. 30 000 times. When switching on, the memory can either be saved or deleted. The free and saved space is indicated.

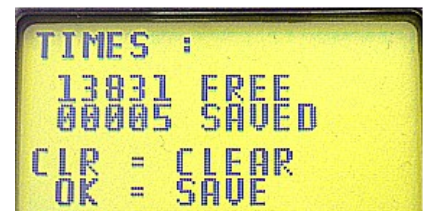

8 Info Mode

Pressing the buttons   opens the info mode. Important data is displayed.

- external power supply Yes or No
- TIMY2 program version
- TIMY2 boot version
- battery voltage
- output voltage
- integrated printer
- hardware number
- state of timing channels (C0, C1, C2, C3)

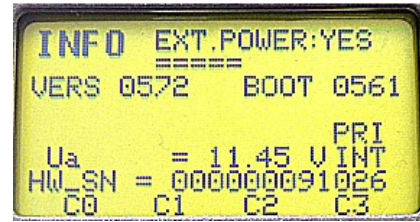

Display with external supply

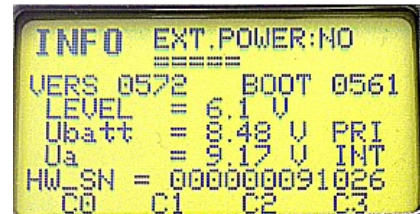

Display without external supply

9 GPS Synchronisation

It is possible to synchronise the TIMY2 with a GPS mouse (GPS-TY). The synchronisation can be effected with all programs and is a up to the 1/10 000 seconds exactly.

- The GPS mouse (picture: GPS 18LVC) needs no external power supply.
- The RS232 baud rate of the TIMY2 has to be set to 9600 Baud.
- In the menu <channels> the item <TED-RX> has to be deactivated.
- The GPS synchronises the TIMY2. After this the TIMY2 runs with its own precision quartz and the GPS can be disconnected. The GPS Mouse can now be used to synchronise further devices.



Instead of the day time setting, the display shows as indicated on the right. As long as it says "NO SIGNAL", the GPS receiver is searching for satellites.



When "OK -UTC +UTC NO" is displayed in the bottom line, the time for your region can be adjusted with keys <F1> and <F2>. As soon as the correct time is shown, press <OK>.

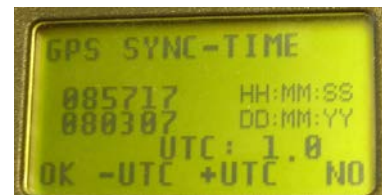

Attention!

After receipt of a valid GPS signal, the TIMY2 verifies the checksum and measures the duration of the sync signal. If the sync signal is erroneous, the TIMY2 carries out a reset. Thus it is impossible to generate an invalid sync time. If the TIMY2 is supplied by external power, it automatically restarts. In case of operation with internal power, the TIMY2 turns off and has to be restarted.

Remove the GPS receiver from the TIMY2. Press <OK> to start the selected program.



10 Menu

The TIMY2 menu allows you to adjust individual settings. Push  to access the main menu. With the cursor buttons you can navigate through the menu.



enter or exit the menu



navigate up or down



next submenu



previous menu



Confirm input or choice

On the following pages the different menu items are described. The program specific menu settings are described in the separately available manuals for each program. Bold printed settings are the **ALGE-TIMING** factory settings.

10.1 CLASSEMENT

The classement menu offers two different options.

10.1.1 ALL

Prints an overall ranking of different saved times. According to each program the following options are available:

- **<RUNTIME>** ranking sorted according to run time
- **<TOTALTIME>** ranking sorted according to total time
- **<PRINT MEMORY>** prints the memory of TIMY2
- **<MEMORYTIME>** prints times of previous heat
- **<PROTOCOLL>** prints a protocol of all times

10.1.2 CLASS

Prints a ranking list of one class. Subsequently, the bibs belonging to this class have to be chosen. Only one class can be printed at a time.

10.1.3 START LIST

This function prints the start list of the second heat.

10.2 GENERAL

In this menu item general settings regarding the timing can be made.

10.2.1 PREC-ROUNDING

Choose precision and mode for calculation of times. The bold printed setting is the factory setting.

10.2.1.1 PRECISION

Setting of calculation precision. Only for net times!

- <1s> calculated times in seconds
- <1/10> calculated times in 1/10 seconds
- **<1/100>** **calculated times in 1/100 seconds**
- <1/1000> calculated times in 1/1 000 seconds
- <1/10000> calculated times in 1/10 000 seconds

10.2.1.2 ROUNDING

All times are always calculated in day times in 1/10 000 seconds. For conversion to the runtime at the required precision, one of the following three methods can be chosen:

- **<CUT>** cuts off the figures not displayed
- <UP> rounds up the last displayed figure
- <ROUND> mathematical rounding of last displayed figure

10.2.2 CHANGE HEAT

Depending on the active program, this item enables moving on to the next heat.

10.2.3 STN-AUTOMATIC

The TIMY2 supports different types of automatic start number continuation for the competitors at start and finish.

10.2.3.1 START

Controls the start number continuation for competitors at the start.

- **<MANUALLY>**
- <UP>
- <DOWN>

10.2.3.2 FINISH

Controls the start number continuation for competitors reaching the finish.

- **<MANUALLY>** no automatic continuation
- <START> only 1 competitor on track from start to finish
- <FINISH> several competitors on track, according to starting order

10.2.3.3 AUTOMATIC-TIME

Set a minimum and maximum runtime. If an impulse is received before the minimum time has expired an invalid time is registered. If the maximum time has expired the finish start number is automatically forwarded to the next started competitor.

- <AUTOTIME-MIN> Standard: **00:00:00** = function disabled
- <AUTOTIME-MAX> Standard: **00:00:00** = function disabled

10.2.4 SEC-MODE

This function sets if runtime is displayed in min/sec or just sec. Not available in all programs

- **<NO>** Runtime in hh:mm:ss.th
- **<YES>** Runtime in ssss:th

10.2.5 LANGUAGE

You can adjust the following languages as defaults for the TIMY2

- <GERMAN>
- <ENGLISH>
- <FRENCH>
- <ITALIAN>
- <SPANISH>
- <SCHWEDISH>

10.2.6 STANDARD

Reset the TIMY2 to the factory defaults.

- <STANDARD-SETT>

10.2.7 HARDWARE

This menu is only available for our service technicians.

10.2.8 HARDWARE 2

This menu is only available for our service technicians.

10.2.9 PROGS ON OFF

As standard all programs are activated. The programs that are not used can be hidden to reduce the select list. Hidden programs can be activated any time in this menu again.

10.3 CHANNELS

Configuration of the timing channels:

10.3.1 INTERNAL

10.3.1.1 DELAY TIME

The delay time of the internal timing channels c0, c1, c2, c3, c4, c5, c6, c7 and c8 can be set. Delay time is the time after which the channel is blocked after an impulse, to prevent multiple impulses (see point 5.2).

- <DELAY START C0> **standard is 1.00 second**
- <DELAY C1-C8> **standard is 0.30 second**
- <DELAY C1> not always available!
- <DELAY C2>
- <DELAY C3>
- <DELAY C4>
- <DELAY C5>
- <DELAY C6>
- <DELAY C7<
- <DELAY C8>

10.3.1.2 TED-CORRECTION

For automatic correction of each channel when impulses are transmitted with 0.1 seconds delay by the TED.

10.3.1.3 EDGE

Setting of triggering the impulses either on closing and/or opening. Standard for all channels is on closing.

10.3.2 BEEP

Switches the channel beep on or off.

- <OFF>
- <ON> Factory default

10.3.3 TED-RX

Activates the multichannel reception by the TED-RX.

- <OFF> Factory default
- <ON>

ATTENTION! If this function is activated the serial interface is occupied by the TED.

10.3.4 CHANNEL-PATTERN

This menu is currently not available. Certain channels can be activated or deactivated.

10.4 DISPLAY

Setting for TIMY2 display and scoreboard.

10.4.1 RUNNING TENTH

In the display and via interface the running time is issued in 1/10. Function not available for all programs. Factory setting: OFF

10.4.2 DELAYTIME 1

The delay time determines for how long the intermediate times are shown on display and scoreboard. The display time can be set e.g. for intermediate times of the running time in seconds. Moreover, this time is also applied for the automatic start number continuation at the finish. Factory default is **03** seconds.

10.4.3 DELAYTIME 2

Setting of display time for total time. Factory default is **03** seconds.

10.4.4 BACK LIGHT

To adjust the back light of the display. Factory default is <ENERGY SAVE>.

10.4.4.1 ENERGY SAVE

Backlight is switched on during external power supply, switched off during battery supply.

10.4.4.2 ON

Backlight is always switched on.

10.4.4.3 AUTOMATIC

Backlight is switched on for 5 seconds with each keystroke and timing impulse.

10.5 INTERFACE

Settings for the RS232 and scoreboard interface. Some settings are only available in certain programs.

10.5.1 DISPLAYBOARD

Settings for ALGE LED displays.

- **<CONTRAST>** adjusts the brightness (0 – 9) of the LED display board
- **<TIME + DATE>** internal time and date of scoreboard is synchronised
- **<DISPLAY MODE>** without function
- **<BAUDRATE>** standard is **2400**, the baud rate of the TIMY2 and also of the scoreboard is set
- **<TIMEOUT>** period after which the display switches to time of day
- **<ADRESS>** address for LED display board
- **<SAFETY CAR>** display mode permanent or flashing
- **<LAPS>** number of laps
- **<CTD→LAP>** manual or automatic
- **<FORMAT>** output of time of day or play time

10.5.2 RS-232

Settings of the RS232 of the TIMY2.

- **<MODE>**
- **<BAUDRATE>** standard is **9600**
- **<SENDE MEMORY>** sends the memory contents of the TIMY2.
- **<HANDSHAKE>**
- **<TRACK-MODE>** norm or ident: change output format (program Tracktimer)
- **<TIMY<->TIMY>** communication between two TIMY2

10.5.3 GSM-MODEM

Setting of modem communication of the TIMY2.

- **<ENTER NR>** enter the number to dial
- **<SEARCH MODEM >** search a connected modem
- **<PIN CODE>** enter the SIM card pin code
- **<STOP GSM-MODEM>** disconnect the connection
- **<MEMORY → SMS** send the memory by SMS

10.6 PRINTER

This menu is for setting the printer parameters.

10.6.1 PRINTER-MODE

- <PRINTER OFF>
- <PRINTER ON > **Standard**
- <PAUSE> Printer stops and times will be saved. Times are printed when printer is switched on again.

10.6.2 PRINT STARTTIME

- < OFF> **Standard**
- < ON >

10.6.3 AUTO LINE FEED

- <0> 0 is standard, enter 0 - 9

10.6.4 START-LOGO

- <OFF>
- <ON> standard

10.6.5 PRINT DAYTIME

- <OFF>
- <ON> standard

10.7 PROGRAM

To change to another program.

ATTENTION! When changing the program all saved times will be deleted!

10.8 Program Specific Settings

Depending on active program this menu item is different.

10.9 KEYBOARD-LOCK

To activates the keypad lock to disable accidental entries. All keys of the TIMY2 are disabled.
To enable the keyboard lock enter 1 2 3 4 5 6.

11 Technical data

Processor:	Siemens C161 with 3,3 V technology
Time reference:	12.8 MHz TCXO or standard quartz
Time resolution:	1/10 000 seconds
Running precision:	Temperature compensated quartz oscillator TCXO: temperature range -25 to 50 °C:.....+/- 2.5ppm (+/- 0.009 sec/h) at aging:.....max. +/- 1 ppm per year at 25°C, calibrated+/- 0.3 ppm
Program Memory:	FLASH memory with 16 MBit
Data Memory:	RAM with 4 MBit, approx. 30 000 times
Display:	monochrome LCD graphic display 128 x 64 pixel with extended temperature range and backlight
Keypad:	silicone keypad, 26 buttons
Connections:	DIN-plug for photocell (7) banana plug pair – start input (5) banana plug pair – finish input (6) banana plug pair – display board (4) D-sub-25 pin (3) <ul style="list-style-type: none"> • 9 timing channels • RS 232 (PC-connection) • display board • RS 485 (network) • power supply (8 - 22 VDC in / 7.5 - 21 VDC out) USB (1) power supply 8 - 22 V DC in (2)
Channel extension:	5 channels per extension, max. 99 channels
Power supply:	Internal: NM-TIMY2 battery pack or 6 x AA-Alkaline 2 Ah (only for TIMY2 XE) External: with charger PS12A, PS12 and 12 V battery or 8 -24 VDC
Operating time:	Alcaline: without printer about 50 hours NM-TIMY2: without printer about 60 hours at 20° C NM-TIMY2: with printer (3 printed lines per minute) about 47 hours at 20° C
Charging:	approx. 18 hours
Printer:	graphic thermal printer, max. 6 lines per second
Temperature range:	TIMY2 XE and PXE: -20 to 60°C
Dimensions:	TIMY2 XE: 204 x 91 x 50 mm TIMY2 PXE: 307 x 91 x 65 mm
Weight:	TIMY2 XE: 450 g (without battery) TIMY2 PXE: 650 g (without battery and paper)

11.1 Pin assignment

USB-Interface (1):

The USB-interface is used as interface between TIMY2 and computer. Via this interface the TIMY2 can completely be controlled and all data can be recalled.

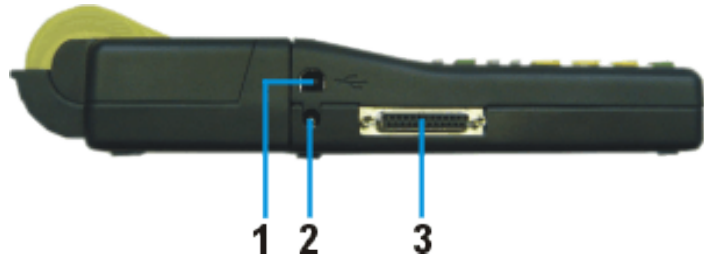

Charger Connection (2):

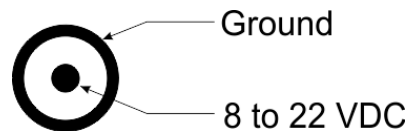

ALGE-Multiport (3):

Pin assignment:

- 1..... terminal numbering connection
- 2.....c0..... start channel (precision 1/10 000 s)
- 3.....c2..... timing channel 2 (precision 1/10 000 s)
- 4.....c3..... timing channel 3 (precision 1/10 000 s)
- 5.....c7..... timing channel 7 (precision 1/100 s)
- 6..... data output for display board
- 7..... RS485B
- 8..... RS485A
- 9..... clock for terminals CLK
- 10..... RS232 TX
- 11..... RS232 RX
- 12..... common ground GND
- 13..... stabilized voltage out (+5V)
- 14.....c1..... stop channel (precision 1/10 000 s)
- 15.....c5..... timing channel 5 (precision 1/10 000 s)
- 16.....c8..... timing channel 8 (precision 1/100 s)
- 17.....c6..... timing channel 6 (precision 1/100 s)
- 18.....c4..... timing channel 4 (precision 1/10 000 s)
- 19..... RS232 RTS
- 20..... printer data out
- 21..... horn output 8 Ω
- 22..... RS232 CTS
- 23..... power supply out: 7.5 - 21 VDC
- 24..... common ground GND
- 25..... power supply in: 8 - 22 VDC

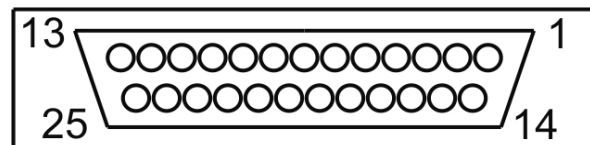

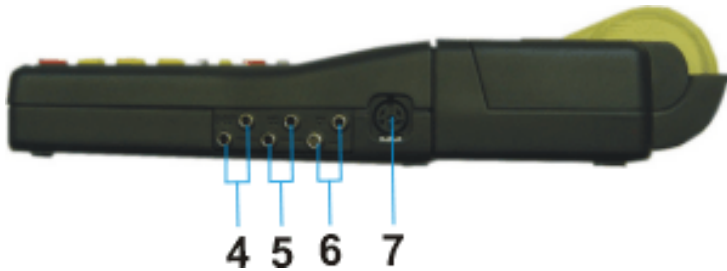

- Banana plugs for display board (4)
- Banana plugs for start channel C0 (5)
- Banana plugs for stop channel C1 (6)



Photocell socket (7)

Pin assignment:

- 1.....c0..... start channel
- 2.....c1..... stop channel
- 3.....GND..... common ground
- 4.....+Ua power supply out 8-22 VDC
- 5.....+5V stabilized voltage out (+5 VDC)
- 6.....c2..... intermediate time channel

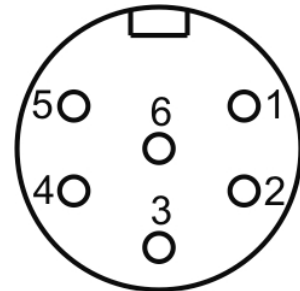

12 Interfaces

12.1 RS232 Interface

Output format: 1 start bit, 8 data bit, no parity bit, 1 stop bit
Bit rate: 9 600 baud factory setting
adjustable: 2400, 4800, 9600, 19200, 28800, 38400

Transmission protocol: ASCII

yNNNNxCCCxHH:MM:SS.zhtqxGGRRRR(CR)

y..... first sign is blank or info (see below)

x..... blank

NNNN..... start number, max. 4-digit, prezeros are not shown

CCC..... channels of timing device

c0..... channel 0..... start channel

c0M..... channel 0..... triggered by keypad <START>

c1..... channel 1..... finish channel

c1M..... channel 1..... triggered by keypad <STOP>

c2..... channel 2

c3..... channel 3

c4..... channel 4

c5..... channel 5

c6..... channel 6

c7..... channel 7

c8..... channel 8

RT..... run time

TT..... total time

SQ..... sequential time (lap time)

kmh..... speed measurement (possible displays: km/h, m/s, mph)

HH:MM:SS.zhtq..... time in hours, minutes, seconds and 1/10 000 seconds

GG..... group, lap or blank

RRRR..... rank (only at classement available)

(CR)..... carriage return

Info – the following figures may be in first position:

x..... blank

?..... time without valid start number

m..... time from memory

c..... times deleted (e.g. with CLEAR button)

C..... memory time deleted (e.g. with CLEAR button)

d..... times deleted due to disqualification

i..... manually entered time with <INPUT>

n..... enter new start number

Example of a RS 232 interface output (e.g. program backup)

```

0001 c0 15:43:49,8863 00          m 0008 c1 15:44:00,2849 00
0002 c0 15:43:50,1647 00          m 0009 c0 15:44:00,5499 00
0005 c1 15:43:51,6464 00          m 0010 c1 15:44:00,8182 00
0006 c0 15:43:51,9669 00          m 0011 c0 15:44:01,0366 00
0007 c1 15:43:52,2467 00          C 0011 c0 15:44:01,0366 00
0008 c0 15:43:52,4579 00          n 0014 c0 15:44:01,0366 00
0009 c1 15:43:52,6941 00          0020 c0 15:44:15,0077 00
0015 c0M 15:43:55,6200 00         0022 c0 15:44:15,5165 00
0016 c1M 15:43:55,8800 00         0023 c1 15:44:15,7847 00
0019 c0M 15:43:57,020 00          c 0023 c1 15:44:15,7847 00
m 0007 c0 15:43:59,9927 00        i 0023 c1 15:44:15,7847 00

```

RT	SAF	SAS	SL	SM	SPDI	SPDR	SPU	SPMI	SPMX	SPTI	SPTIO	TER	TIMYINIT	DTC	DTP	CLR	CHK	EMU	RSP	RSS	RSUA	RSUB	SPEC	SYNA	SYNM	SYND	SSST	DTPH	HELP	
running tenth	sin automatic for finish	sin automatic for start	START_LOGO	second mode	Speed distance in meters	Speed direction	Speed Unit	Speed minimum	Speed maximum	Speed Print Times	Only for the communication with the OPTIC-device.	Advanced subset of data-chain	initialize the timy, gets HW-ID	Delaytime for a specific channel	Direct transmission to printer	clears the memory	enables or disables the checksum	send time every s or mths or rtd	send memory from pos. a to b	send memory from STN a to b	Send memory universal A	Send memory universal B	Special command	Synchronize the Timy	Send start time	Direct transmission to printer	Show the list of the commands			
0 or 1	0.1 or 2	0.1 or 2	0 or 1	0 or 1	0000.1 to 9999.9 or 0001 to 9999 or ?	0.1 or 2	0.1 or 2	0000.1 to 9999.9 or 0001 to 9999 or ?	0001.0 to 9999.9 or 0001 to 9999 or ?	0001.0 to 9999.9 or 0001 to 9999 or ?	0 or 1	Only for the communication between the OPTIC and the Timy.	? Or #12.34 (while # = 0 to 8)	max. 24 characters		?,0 or 1	?;0.1 or 2	aaaaabbbb	aaaaabbbb	Caaaabbbb	Caaaaabbbb	Caaaaabbbb	Caaaaabbbb	Timy to Timy connection over RS232	hh:mm:ss:zhz	hh:mm:ss:zhz	YY:MM:DD	NNNN CO hh mm:ss:zhz RR	max. 100 characters	
RT0 RT1 RT7	SAF0 SAF1 SAF2	SAS0 SAS1 SAS2	SLO SL1 SL7	SM0 SM1 SM7	SPDI0100<cr> SPDI0100.5<cr>	SPDR0 SPDR1	SPU0 SPU1 SPU2	SPMI0000.1	SPMX02010	SPTI1 SPTIO		TERFET	TIMYINIT	DTC#01.78	DTPHelloWorld	CLR	CHK2,CHK1,CHK0	EMU7,EMU0,EMU2	RSP0001000500	RSS0002000020	RSUA100106999	RSUA0000000020	RSUBA0000000020	SPEC?	SYNA12:00:00.0000	SYNM00:30:00.0000	SYND04-10-31	SST 1234 CO 12:34:56 7890 00 NNNN=Startnumber, hh=hour mm=minutes	DTPHelloWorld	HELP
request, on off	request, 0 = off, 1=start, 2=fin sh	request, 0 = off, 1=up, 2=Down	request, on off	request, set	request, set	request, set	request, 0=kmh, 1=mh, 2=ms	set, request = SPM0000.1 always XXXX.X	set, request = SPMX0200.0 always XXXX.X	request, set		gets the hardware-Id of the Timy	request, set	LOOK FURTHER BELOW	request, set	request, set	gets the memory from pos. 10 to 500	gets the memory from stn. 20 (to 20)	C=0..9 or A,aaa=string,bbb=stn_end	All lines, having channel 1 and stn >= 10 and stn <=9999 are sent.	All times, having stn <= 20 are sent.	All times, having stn <= 20 are sent.	request, set	manually sync, waits for sync-impulse	enter the sync date, takes only effect when SYN# is followed	ss=seconds, zhZ=4 digits of seconds fraction	RR = always 00	Timy shows the list of the supported comm		
X	X	X	X	X	X	X	X	X	X	X	X	X	X	X	X	X	X	X	X	X	X	X	X	X	X	X	X	X	X	

Note: if you see <cr> at an example, please be aware that this is only one character not 4 characters.

12.2 RS485 Interface

This interface is only used for special applications such as wind speed measurement, TIMY2 Terminal etc.

12.3 Interface for displayboard

Output format: 1 start-bit, 8 data-bit, no parity-bit, 1 stop-bit
Bit rate: factory setting: 2400 baud (necessary for ALGE GAZ displayboard)
 2400, 4800, 9600, 19200, 28800, 38400
Transmission protocol: ASCII

NNN . xxxxxxxxM : SSxxxx (CR)	Running time (without 1/10 seconds)
NNN . xxxxxHH : MM : SSxxxx (CR)	Running time (without 1/10 seconds)
NNN . xxxxxHH : MM : SS . zxx (CR)	Running time (with 1/10 seconds)
NNNCxxxxHH : MM : SS . zhtRR (CR)	Channel C1 finish time with rank
NNNCxxxxHH : MM : SS . zhtxx (CR)	Channel C1 finish time without rank
NNNDxxxxHH : MM : SS . zhtRR (CR)	Channel C1 total time with rank
NNNDxxxxHH : MM : SS . zhtxx (CR)	Channel C1 total time without rank
NNNAxxxxHH : MM : SS . zhtRR (CR)	Channel C2 1. intermediate time
NNNBxxxxHH : MM : SS . zhtRR (CR)	Channel C3 2. intermediate time
NNNExxxxHH : MM : SS . zhtRR (CR)	Channel C4 3. intermediate time
NNNFxxxxHH : MM : SS . zhtRR (CR)	Channel C5 4. intermediate time
NNNGxxxxHH : MM : SS . zhtRR (CR)	Channel C6 5. intermediate time
NNNHxxxxHH : MM : SS . zhtRR (CR)	Channel C7 6. intermediate time
NNNIxxxxHH : MM : SS . zhtRR (CR)	Channel C8 7. intermediate time
NNNSxxx©xxxxsxss . ssxRR (CR)	Speed

NNN Start number (hundreds, tens, ones - digit 1 to 3)
 a point on the fourth digit is the identification for a running time
 HH:MM:SS.zht time in hours, minutes, seconds and 1/1000 seconds
 © speed measurement: output of following ASCII signs: 01 hex for km/h, 02 hex for m/s, 03 hex for mph
 RR rank
 x blank
 (CR) carriage return

13 USB Interface

Currently possible applications for USB interface:

- update the TIMY2 software with installation manager or TIMY2 USB program
- query and change of settings (as RS232)
- recording of times with program ComtoFile
- evaluation with program Time.NET
- evaluation with program Excel Writer

Subject to changes

Copyright by

ALGE-TIMING GmbH
Rotkreuzstr. 39
6890 Lustenau / Austria
www.alge-timing.com