

ALGE-TIMING

Timing



General

Important Information

General

Before using your **ALGE-TIMING** device read the complete manual carefully. It is part of the device and contains important information about installation, safety and its intended use. This manual cannot cover all conceivable applications. For further information or in case of problems that are mentioned not at all or not sufficiently detailed, please contact your **ALGE-TIMING** representative. You can find contact details on our homepage www.alge-timing.com

Safety

Apart from the information of this manual all general safety and accident prevention regulations of the legislator must be taken into account.

The device must only be used by trained persons. The setting-up and installation must only be executed according to the manufacturer's data.

Intended Use

The device must only be used for its intended applications. Technical modifications and any misuse are prohibited because of the risks involved! **ALGE-TIMING** is not liable for damages that are caused by improper use or incorrect operation.

Power supply

The stated voltage on the type plate must correspond to voltage of the power source. Check all connections and plugs before usage. Damaged connection wires must be replaced immediately by an authorized electrician. The device must only be connected to an electric supply that has been installed by an electrician according to IEC 60364-1. Never touch the mains plug with wet hands! Never touch live parts!

Cleaning

Please clean the outside of the device only with a smooth cloth. Detergents can cause damage. Never submerge in water, never open or clean with wet cloth. The cleaning must not be carried out by hose or high-pressure (risk of short circuits or other damage).

Liability Limitations

All technical information, data and information for installation and operation correspond to the latest status at time of printing and are made in all conscience considering our past experience and knowledge. Information, pictures and description do not entitle to base any claims. The manufacturer is not liable for damage due to failure to observe the manual, improper use, incorrect repairs, technical modifications, use of unauthorized spare parts. Translations are made in all conscience. We assume no liability for translation mistakes, even if the translation is carried out by us or on our behalf.

Disposal

If a label is placed on the device showing a crossed out dustbin on wheels (see drawing), the European directive 2002/96/EG applies for this device.

Please get informed about the applicable regulations for separate collection of electrical and electronical waste in your country and do not dispose of the old devices as household waste. Correct disposal of old equipment protects the environment and humans against negative consequences!



Copyright by **ALGE-TIMING GmbH**

All rights reserved. Any duplication, either in full or in part, requires the prior written consent of the copyright holder.

Copyright by **ALGE-Timing**

Subject to changes!

ALGE-TIMING GmbH

Rotkreuzstraße 39

A-6890 Lustenau

www.alge-timing.com

Control elements

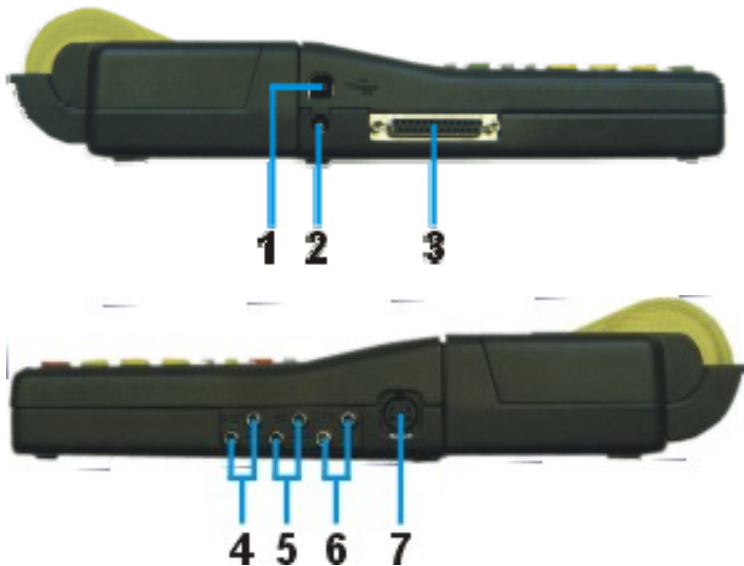

- 1 USB-interface
- 2 Charging socket
- 3 **ALGE** multiport
- 4 Connection for displayboard
- 5 Connection for start emitter (C0)
- 6 Connection for finish emitter (C1)
- 7 Standard **ALGE** photocell socket

Table of contents

1	Device Description	5
1.1	<i>TIMY Models</i>	5
1.2	<i>TIMY Software</i>	6
1.3	<i>Driver Installation</i>	6
1.4	<i>Keypad.....</i>	7
2	Start Up	8
2.1	<i>Switch On.....</i>	8
2.2	<i>Switch Off.....</i>	8
2.3	<i>Choose Language.....</i>	8
2.4	<i>Power Supply.....</i>	9
3	Printer	10
3.1	<i>Change of Paper.....</i>	10
4	Synchronising	11
4.1	<i>Synchronisation of Other Devices with a TIMY:.....</i>	11
5	Connection of Auxiliary Devices.....	11
5.1	<i>Channels.....</i>	11
5.2	<i>Delay and Block Times</i>	11
5.3	<i>Diagram of Delay and Block Time</i>	12
6	TIMY Update.....	12
6.1	<i>Update with Cable 205-02</i>	13
6.2	<i>Update with USB Cable</i>	14
7	Memory.....	14
8	Info Mode	14
9	GPS Synchronisation.....	15
10	Menu	16
10.1	<i>CLASSEMENT.....</i>	16
10.2	<i>GENERAL.....</i>	17
10.3	<i>CHANNELS</i>	18
10.4	<i>DISPLAY.....</i>	19
10.5	<i>INTERFACE.....</i>	19
10.6	<i>PRINTER</i>	20
10.7	<i>PROGRAM</i>	20
10.8	<i>Program Specific Settings.....</i>	20
10.9	<i>KEYBOARD-LOCK.....</i>	20
11	Technical data	21
11.1	<i>Pin assignment</i>	22
12	Interfaces	24
12.1	<i>RS232 Interface</i>	24
12.2	<i>RS485 Interface</i>	27
12.3	<i>Interface for displayboard</i>	27
13	USB Interface	27

1 Device Description

The **ALGE** TIMY is a handy device, equipped with high-quality technology.

During the development, we have paid special attention to the self-evident principles of **ALGE-Timing**: ease of operation, extreme reliability and robust design. Latest technology, integrated into a casing especially designed for timing, result in a unique device.

In spite of the handy dimensions, the TIMY provides a large and easy-to-use silicone keypad. It can be operated easily in any weather condition and even with gloves. The model TIMY PXE has an integrated printer that records the entire competition.

Of course, the TIMY is also equipped with the necessary interfaces for communication with external devices. It possesses an interface for display boards, an RS232 interface for communication with a PC, an RS485 interface to establish a network of timing devices and a future-proof USB interface.

The generously dimensioned memory of the TIMY can store up to 15 000 times. All memory times can be shown on the display or transmitted to a PC by RS 232 or USB interface at any time.

1.1 TIMY Models

TIMY S (not produced any more!) :

TIMY S is a timing device or terminal without printer. Equipped with a standard quartz, it performs timing tasks with quartz-accuracy. The display works up to -5°C (summer sports or indoor).

TIMY XE:

TIMY XE is a timing device without printer. Equipped with a temperature compensated quartz-oscillator, it performs timing tasks with highest accuracy. The extended temperature range enables using the TIMY up to -20°C (for summer and winter sports).

TIMY P (not produced any more!) :

TIMY P is a timing device or terminal with integrated printer. Equipped with a standard quartz, it performs timing tasks with quartz-accuracy. The display works up to -5°C (summer sports or interior).

TIMY PXE:

TIMY PXE is a timing device with integrated printer. Provided with a temperature compensated quartz-oscillator, it will perform timing tasks with highest accuracy. The extended temperature range enables using the TIMY up to -20°C (for summer and winter sports).



1.2 *TIMY Software*

Starting from TIMY version V0591 all programs are activated for free. We recommend to update older versions.

Currently available programs:



Stopwatch:	Universal timing program which is suitable for several runs (run/total time).
Backup:	to measure time-of-day times (e. g. as backup-system or as time reference for the PC)
PC-Timer:	to measure time-of-day times with simultaneous output of the running time in 1/10 seconds via the RS232 interface. Ideal as an accurate timing device for PC
LapTimer:	Timing program with run times and lap times (e. g. for motor sport)
TrackTimer:	Timing program for events with several lanes, e. g. athletics and swimming
Training Lite:	Universal training software (intermediate times are possible)
Training REF:	Training software with reference run (several competitors on course)
Speed:	Speed measurement
Commander:	Terminal for diverse subprograms (see manual)
CycleStart:	Program for track cycling with countdown and lap counter
Terminal:	Terminal for judges (e. g. gymnastics)
Wind Speed:	Measuring the windspeed only with anemometer WS2
Parallelsalom:	Timing for parallel slalom (difference time of both slopes)
Dual Timer:	Timing of two separate courses

1.3 *Driver Installation*

For installation of drivers, separate manuals are available. You can download them on our homepage www.alge-timing.com or contact your ALGE representative.

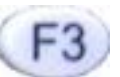

1.4 Keypad

The TIMY has a weather-proof (and water-proof) silicone keypad. The keypad is ideal for outdoor usage. The keys are raised and have ideal pressure points. Although the TIMY is small in dimensions, they are easy to operate.

    **Control keys:** all-purpose keys; the function of each one is always visible in the display.

 **START/ON:** Key for manual start impulse and to switch on the TIMY.

 **STOP/OFF:** Key for manual stop impulse and to switch off the TIMY.

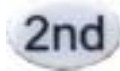

 **Printer:** Key for paper output. If you press the combination  and , you open the printer menu.

 **2nd:** This key is always used in combination with a second key (additional function).

 **Menu:** Key to enter the device menu.

 **CLR:** Key to clear the marked times or to clear the memory.

    **Cursor:** Keys to move the cursor in the display.

 +  Beginning of a list

 +  End of a list

 **OK green:** To confirm the commands, to confirm start inputs or to switch the TIMY on.

 **OK red:** To confirm the commands, to confirm finish inputs or to switch the TIMY off.

2 Start Up

2.1 Switch On

- Press button „START/ON“
- Display shows:
- “Really switch-on? Press the green OK-button!”
- If you press the green OK-button within 10 seconds, the TIMY will start, otherwise it will automatically switch-off.



2.2 Switch Off

You have got two possibilities to switch off the TIMY:

Method 1:

- Press button „STOP/OFF“ for 3 seconds
- Display shows:
- “Really switch-off? Press the red OK-button!”
- If you press the red OK-button within 10 seconds, the TIMY will switch off, otherwise it starts again at the last used programm.



Method 2:

- Press buttons „2nd“ and „STOP/OFF“
- Display shows:
- “Really switch-off?” Press the green OK-button.
- If you press the red OK-button within 10 seconds, the TIMY will switch off. Otherwise it will automatically stay switched on.



2.3 Choose Language

Currently, you can choose between the following languages: German, English, French and Italian.

Press the menu button to enter the main menu. Choose “general”, “language” and then “requested language”. Choose desired language and press menu button to reenter the run mode.

2.4 Power Supply

The TIMY has several possibilities for power supply:

External supply +8 to 15 VDC:

- Power supply unit PS12
- Power supply unit PS12A , ideal as the deltron socket remains free
- External battery e.g. 12V plumb rechargeable battery

NLG4 and **NLG8** must NOT be used as the off-load voltage is too high (TIMY might be destroyed!).

With external supply of at least 11.5 VDC, the internal rechargeable battery is charged.

Internal supply:

The battery compartment has space for 6 batteries type AA or rechargeable batteries. For TIMY P or PXE you have to use the heat-sealed rechargeable battery-packs ONLY!

Timy	Timy S		Timy XE		Timy P		Timy PXE	
	below 5°C	above 5°C	below 5°C	above 5°C	below 5°C	above 5°C	below 5°C	above 5°C
Alkaline Batteries	yes	yes	yes	yes	no	no	no	no
NiCd-Rechargeable	yes	yes	yes	yes	no	no	no	no
NiMH-Rechargeable	no	yes	no	yes	no	no	no	no
NC-TIMY Battery Pack	yes	yes	yes	yes	yes	yes	yes	yes

Battery types:

Alkaline batteries: *These batteries must never be used with a TIMY with integrated printer!*

At a temperature of -20°C , alkaline batteries have only 10% of their original capacity so they are only recommendable at warm weather conditions.

Also out of environmental reasons we would recommend rechargeable batteries.

NiMH rechargeable battery: The NiMH-rechargeable batteries can be used with a TIMY without printer, if used at temperatures higher than 5°C . The NiMH-rechargeable battery has a very poor performance at cold temperature.

Attention: The TIMY with integrated printer must never be operated with this kind of rechargeable batteries!

NiCd rechargeable battery: The NiCd-rechargeable battery is especially powerful at at temperatures below 5°C .

Attention: The TIMY with integrated printer must never be operated with this kind of rechargeable batteries!

NC-TIMY: NiCd-rechargeable battery block, especially designed for the TIMY. All TIMY with intergrated printer have to be operated with this accu block. Using another kind of batteries may cause a battery warning after some printouts and cease operation.

Charging:

The rechargeable batteries can be charged inside the TIMY with charger PS12 or PS12A, no matter if the TIMY is switched on or off.

Depending on the type of rechargeable battery, the charging period is different:

- NiCd rechargeable battery with 1 Ah approx. 14 hours
- NiMH rechargeable battery with 1,5 Ah approx. 18 hours

If you want to reduce the charging period, we recommend using the desk charger LG6AA. It is available with your **ALGE**-representative. However, you have to remove the rechargeable batteries from the TIMY.

Charging switch:

The TIMY has got a switch (hidden behind the battery label) for switching on or off the rechargeable battery charging.

Using alkaline batteries, the charging must be switched off -position ALKALI-, as otherwise the TIMY can be destroyed by leakage of the batteries.

During the operation with rechargeable batteries, the switch should be on position NiCd/NiMH so that the rechargeable batteries are charged.

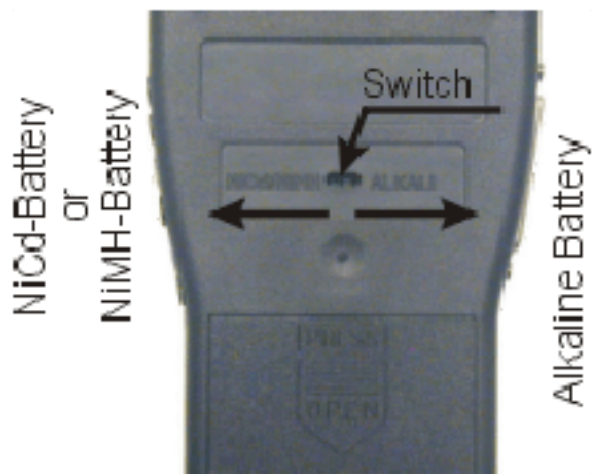

Attention: Never use alkaline batteries in a TIMY when the charging switch is set on NiCd/NiMH and a charger is connected.

Operating period:

The operating period depends on the TIMY Model, the batteries utilized and the ambient temperature.

3 Printer

TIMY P and PXE dispose of an integrated thermal printer. The best paper for the printer is our **ALGE** paper. It is recognizable by the **ALGE** logo print on the reverse side, available with your **ALGE** representative.

3.1 Change of Paper

- open printer cap
- take out the paper axis
- place the axis inside the paper roll
- insert paper roll with axis into TIMY
- thread paper through tear-off edge
- close printer cap

4 Synchronising

For synchronising the TIMY, please follow the below instruction:

- connect TIMY with cable 000-xx or 004-xx with other timing devices.
- switch on the TIMY
- clear or retain memory
- retain time and date or correct it and confirm or trigger with START button or via channel C0.

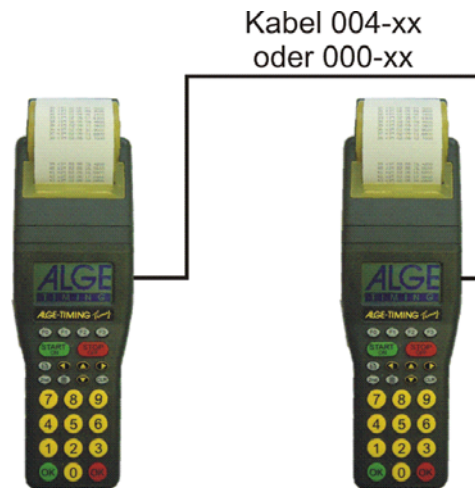

4.1 Synchronisation of Other Devices with a TIMY:

The TIMY can send a synchronisation signal via channel 0 every full minute when using the programs BACKUP or PC-TIMER.

- connect the TIMY with the device to be synchronized
- enter the time of day (next full minute) to be synchronized at the device
- press and hold both buttons, the green and red OK button of the TIMY; on the full minute the TIMY sends a synchronisation impulse. The time of day of the timing device now runs.

5 Connection of Auxiliary Devices

A wide range of devices can be operated with the TIMY. Please ask your ALGE representative for the possibilities.

5.1 Channels

The TIMY has 9 independent timing channels.

Attention: Channels 0 to 5 have a precision of 1/10 000 seconds but channel 6 to 8 only 1/100 seconds.

5.2 Delay and Block Times

The variable delay times and blocked times prevent generating double impulses and losing impulses. The delay time and the blocked time can be changed in the menu.

5.2.1 Delay Time

After triggering an impulse, further impulses of the same impulse channel will be disabled for the duration of the delay time.

Base settings:	start channel	C0	0.1s
	stop channel	C1 to C9	0.03s

5.2.2 Block Time

The block time is the theoretic minimum interval between two valid impulses of the same channel. Impulses within the block time are saved as invalid. The block time is only supported by certain programs.

That is to say, for an interval start of every 30 seconds the minimum clearance is approx. 20 seconds. Thus the block time is 20 seconds, too.

5.3 Diagram of Delay and Block Time

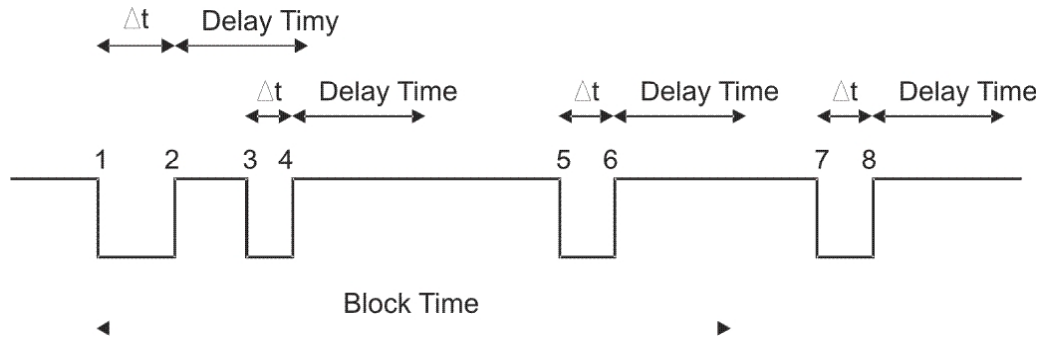

- e t timing channel triggered
- 1 timing channel is triggered – valid time is saved – block time starts
- 2 end of impulse – delay time starts
- 3 timing channel is triggered within the delay time – no impulse triggering
- 4 end of impulse – delay time restarts
- 5 timing channel is triggered within the block time – invalid time is saved but not printed
- 6 end of impulse – delay time starts
- 7 timing channel is triggered – valid time is saved – block time starts

6 TIMY Update

You update your TIMY for free – please visit our homepage www.alge-timing.com .

6.1 Update with Cable 205-02



- log into the internet
- choose language
- click on „download“ in the left column
- click on „ALGE devices software (Flash Technology)“
- if not installed yet, download “*Install Manager*”
- open *Install Manager* and connect TIMY with cable 205-02 to the PC
- click on “firmware RS232” in the *Install Manager*
- the firmware automatically searches for TIMY
- switch on the TIMY
- as soon as firmware recognizes the TIMY, the following is displayed
- choose method of update; recommendable is an internet update as the latest version is always available

6.2 Update with USB Cable

- if not yet done, the TIMY USB driver has to be installed
- find the TIMY USB driver at Download/PC-Software/TIMY USB Update
- start the *Install Manager* and click on TIMY USB
- choose method of update

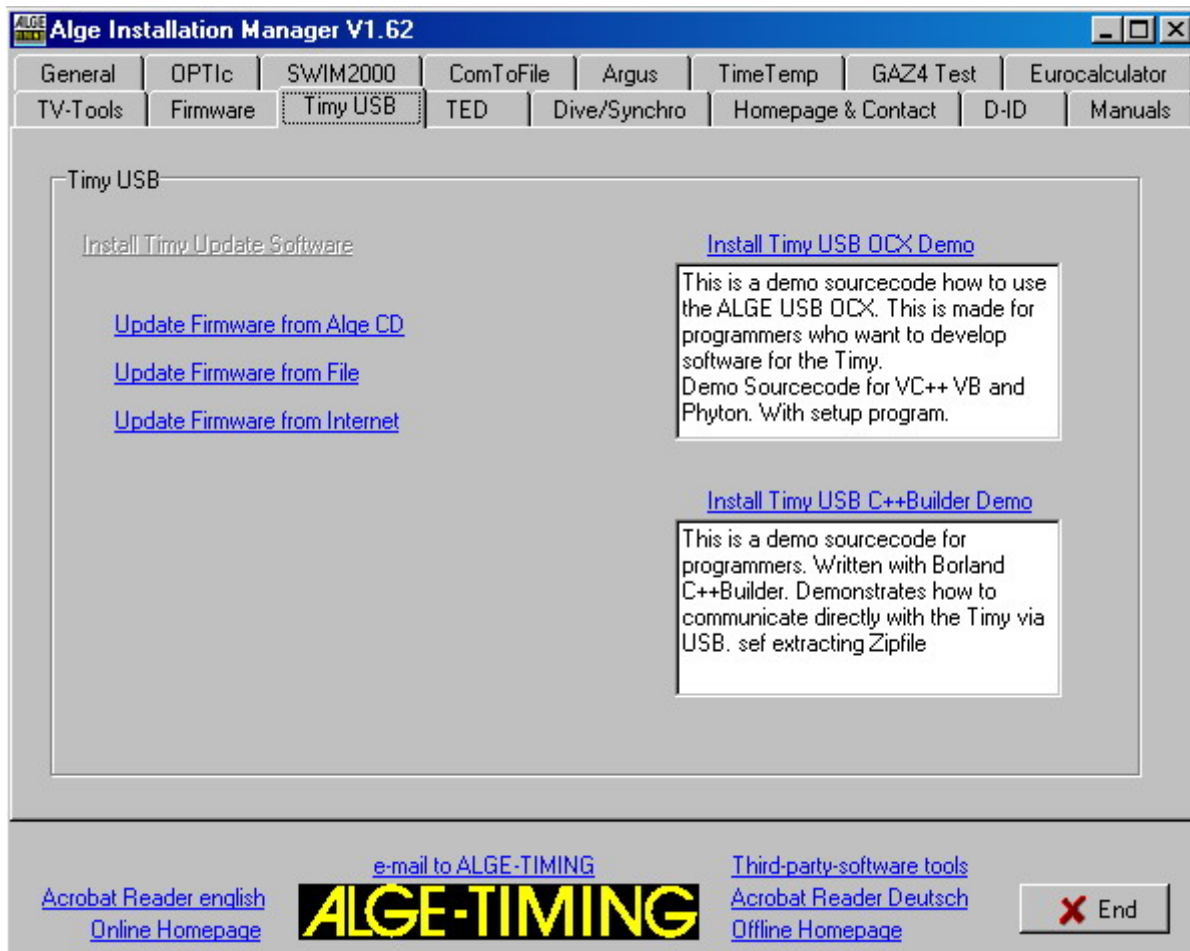

7 Memory

The memory of the TIMY can store approx. 13,000 times. When switching on, the memory can either be saved or deleted. The free and saved space is indicated.

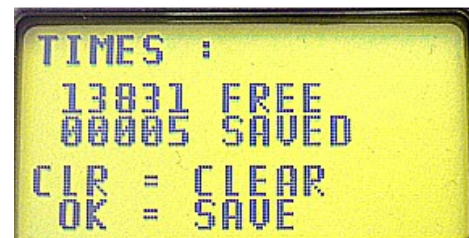

8 Info Mode

Pressing the buttons opens the info mode. Important data is displayed.

- external power supply – Yes or No
- TIMY program version
- TIMY boot version

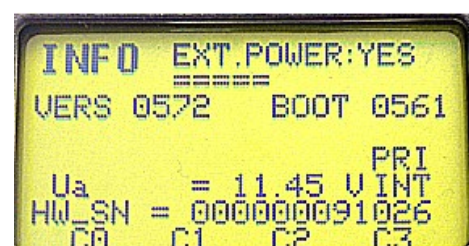

- battery voltage
- output voltage
- integrated printer
- hardware number
- state of timing channels (C0, C1, C2, C3)

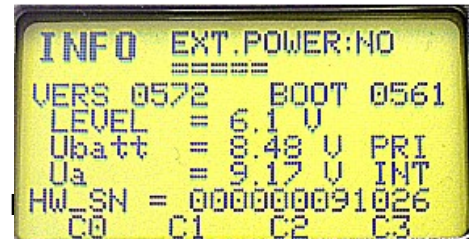

9 GPS Synchronisation

It is possible to synchronise the TIMY with a GPS mouse. The GPS mouse “GPS-TY” works with all programs. The accuracy of such a synchronisation is up to 1/10 000 seconds.

- The GPS mouse (picture: GPS 18LVC) needs no external power supply.
- The baud rate of the TIMY has to be set to 9600 Baud.
- In the menu <channels> the item <TED-RX> has to be deactivated.
- The GPS synchronises the TIMY. After this the TIMY runs with its own precision quartz and the GPS can be disconnected. The GPS Mouse can now be used to synchronise further devices.



Instead of the day time setting, the display shows as indicated on the right. As long as it says “NO SIGNAL”, the GPS receiver is searching for satellites.



When “OK -UTC +UTC NO” is displayed in the bottom line, the time for your region can be adjusted with keys <F1> and <F2>. As soon as the correct time is shown, press <OK>.



Attention!

After receipt of a valid GPS signal, the TIMY verifies the checksum and measures the duration of the sync signal.

If the sync signal is erroneous, the TIMY carries out a reset. Thus it is impossible to generate an invalid sync time.

If the TIMY is supplied by external power, it automatically restarts. In case of operation with internal power, the TIMY turns off and has to be restarted.

Remove the GPS receiver from the TIMY. Press <OK> to start the selected program.



10 Menu

The TIMY menu allows you to adjust individual settings. Push  to access the main menu. With the cursor buttons you can navigate through the menu.



enter or exit the menu



navigate up or down



next



previous



Confirm the entry

On the following pages the different menu items are described.

The program specific menu settings are described in the separately available manual for each program.

Bold printed settings are the **ALGE-TIMING** factory settings.

10.1 **CLASSEMENT**

The classement menu offers two different options depending on the active program.

10.1.1 *ALL*

Prints an overall ranking of different saved times. According to each program the following options are available:

- **<RUNTIME>** ranking sorted according to run time
- **<TOTALTIME>** ranking sorted according to total time
- **<PRINT MEMORY>** prints the memory
- **<MEMORYTIME>** prints times of previous heat
- **<PROTOCOLL>** prints a protocol of all times

10.1.2 *CLASS*

Prints a ranking of one class. Then choose the start numbers for this class. Only one class can be printed at a time.

10.1.3 *START LIST*

This function prints the start list of the second heat.

10.2 GENERAL

In this menu item general settings regarding the timing can be made.

10.2.1 PREC-ROUNDING

Choose precision and mode for calculation of times.

10.2.1.1 PRECISION

Setting of calculation precision. Only for net times!

- <1s> calculated times in seconds
- <1/10> calculated times in 1/10 seconds
- **<1/100> calculated times in 1/100 seconds**
- <1/1000> calculated times in 1/1 000 seconds
- <1/10000> calculated times in 1/10 000 seconds

10.2.1.2 ROUNDING

All times are always calculated in day times in 1/10 000 seconds. For conversion to the run-time at the required precision one of the following three methods can be chosen:

- **<CUT>** cuts off the figures not displayed
- <UP> rounds up the last displayed figure
- <ROUND> mathematical rounding of last displayed figure

10.2.2 CHANGE HEAT

Depending on the active program, this item enables moving on to the next heat.

10.2.3 STN-AUTOMATIC

The TIMY supports different types of automatic start number continuation for the competitors at the start and reaching the finish.

10.2.3.1 START

Controls the start number continuation for competitors at the start.

- **<MANUALLY>** no automatic continuation
- <UP> automatically counts up
- <DOWN> automatically counts down

10.2.3.2 FINISH

Controls the start number continuation for competitors reaching the finish.

- **<MANUALLY>** no automatic continuation
- <START> only 1 competitor on track from start to finish
- <FINISH> several competitors on track, according to starting order

10.2.3.3 AUTOMATIC-TIME

Set a minimum and maximum runtime. If an impulse is received before the minimum time has expired an invalid time is registered. If the maximum time has expired the finish start number is automatically forwarded to the next started competitor.

- <AUTOTIME-MIN> Standard: **00:00:00** = function disabled
- <AUTOTIME-MAX> Standard: **00:00:00** = function disabled

10.2.4 SEC-MODE

This function sets if runtime is displayed in min/sec or just sec. Not available in all programs

- **<NO>** Runtime in hh:mm:ss.th
- <YES> Runtime in ssss:th

10.2.5 LANGUAGE

You can adjust the following languages as defaults for the TIMY

- <GERMAN>
- <ENGLISH>
- <FRENCH>
- <ITALIAN>
- <SPANISH>
- <SCHWEDISH>

10.2.6 STANDARD

Reset the TIMY to the factory defaults.

- <STANDARD-SETT>

10.2.7 HARDWARE

This menu is only available for our service technicians.

10.2.8 PROGS ON OFF

As standard all programs are activated. The programs that are not used can be hidden to reduce the select list. Can be unhidden any time.

10.3 CHANNELS

Configures the timing channels.

10.3.1 INTERNAL

10.3.1.1 DELAY

The delay time of the internal timing channels c0, c1, c2, c3, c4, c5, c6, c7 and c8 can be set. (see point 5.2).

- <DELAY START C0> **standard is 1.00 second**
- <DELAY C1-C8> **standard is 0.30 second**
- <DELAY C1>
- <DELAY C2>
- <DELAY C3>
- <DELAY C4>
- <DELAY C5>
- <DELAY C6>
- <DELAY C7<
- <DELAY C8>

10.3.1.2 TED-CORRECTION

For automatic correction of each channel when impulses are transmitted with 0.1 seconds delay by the TED.

10.3.1.3 EDGE

Setting of triggering the impulses either on closing or opening. Standard for all channels is on closing.

10.3.2 *BEEP*

Switches the channel beep on or off.

- **<OFF>**
- **<ON>** Factory default

10.3.3 *TED-RX*

Activates the multichannel reception by the TED-RX.

- **<OFF>** Factory default
- **<ON>**

ATTENTION! If this function is activated the serial interface of the TIMY is occupied by the TED.

10.3.4 *CHANNEL-PATTERN*

This menu is currently not available. Certain channels can be activated or deactivated.

10.4 *DISPLAY*

Setting for TIMY display and scoreboard.

10.4.1 *RUNNING TENTH*

In the display and via interface the running time is issued in 1/10. Function not available for all programs.

- **<OFF>** Factory default
- **<ON>**

10.4.2 *DELAYTIME 1*

The delaytime determines for how long the intermediate times are shown on display and scoreboard. The display time can be set e.g. for intermediate times of the running time in seconds. Moreover, this time is also applied for the automatic start number continuation at the finish.

Factory default is **03** seconds.

10.4.3 *DELAYTIME 2*

Setting of display time for total time.

Factory default is **03** seconds.

10.5 *INTERFACE*

Settings for the RS232 and scoreboard interface.

Some settings are only available in certain programs.

10.5.1 *DISPLAYBOARD*

Settings for **ALGE** LED displays.

- **<CONTRAST>** adjusts the brightness of the LED display
- **<TIME + DATE>** internal time of scoreboard is synchronised
- **<DISPLAY MODE>** without function
- **<BAUDRATE>** standard is **2400**, the baudrate of the TIMY and also of the scoreboard is set
- **<TIMEOUT>** period after which the display switches to time of day
- **<ADRESS>** Address of the LED display board
- **<SAFETY CAR>** display mode permanent or flashing
- **<LAPS>** number of laps
- **<CTD→LAP>** manual or automatic

10.5.2 RS-232

Settings of the RS232.

- **<MODE>**
- **<BAUDRATE>** standard is **9600**
- **<SENDE MEMORY>** sends the memory contents of the TIMY.
- **<HANDSHAKE>**
- **<TRACK-MODE>** Norm or ident: changes the output format in the program Tracktimer
- **<TIMY<->TIMY>** communication between 2 TIMYs

10.5.3 GSM-MODEM

Setting of modem communication.

- **<ENTER NR>** enter the number to dial
- **<SEARCH MODEM >** search a connected modem
- **<PIN CODE>** enter the SIM card pin code
- **<STOP GSM-MODEM>** disconnect the connection
- **<MEMORY → SMS** send the memory by SMS

10.6 PRINTER

Settings of the printer.

10.6.1 PRINTER-MODE

- **< OFF>**
- **< ON >** Standard

10.6.2 PRINT STARTTIME

- **< OFF>** Standard
- **< ON >**

10.6.3 AUTO LINE FEED

- **<0>** **0 is standard**, enter 0 - 9

10.6.4 START-LOGO

- **<OFF>**
- **<ON>** standard

10.6.5 PRINT DAYTIME

- **<OFF>**
- **<ON>** standard

10.7 PROGRAM

Changes the active program.

ATTENTION! When changing the program all saved times are deleted!

10.8 Program Specific Settings

Depending on active program these settings are different.

10.9 KEYBOARD-LOCK

Activates the keyboard lock to disable accidental entries. All internal keys of the TIMY are disabled. To enable the keyboard press 1 2 3 4 5 6.

11 Technical data

Processor:	Siemens C161 with 3,3 V technology
Time reference:	12.8 MHz TCXO
Time resolution:	1/10 000 seconds
Running precision:	<p>Temperature compensated quartz oscillator TCXO: temperature range -25 to 50 °C: +/- 2.5ppm (+/- 0.009 sec/h) at aging: max. +/- 1 ppm per year at 25°C, calibrated +/- 0.3 ppm</p> <p>Standard quartz: temperature range -25 to 50 °C: +/- 50ppm (+/- 0.18 sec/h) at aging: max. +/- 5 ppm per year at 25°C, calibrated +/- 0.85 ppm</p>
Program Memory:	FLASH memory with 8 MBit
Data Memory:	RAM with 2 MBit, approx. 15 000 times
Display:	monochrome LCD graphic display 128 x 64 pixel, available with standard or extended temperature range
Keypad:	silicone keypad, 26 buttons
Connections:	DIN-plug for photocell (7) banana plug pair – start input (5) banana plug pair – finish input (6) banana plug pair – displayboard (4) D-sub-25 pin (3) <ul style="list-style-type: none"> • 9 timing channels • RS 232 (PC-connection) • displayboard • RS 485 (network) • power supply (8 - 15 VDC in / 7.5 - 14,5 VDC out) USB (1) power supply 8 - 15 V DC in (2)
Channel extension:	5 channels per extension, max. 99 channels
Power supply:	<p>Internal: NC-TIMY battery pack or 6 x AA-Alkaline 2 Ah or 6 x AA-NiCd 1 Ah or 6 x AA-NiMH 1,5 Ah</p> <p>External: with charger PS12A, PS12 and 12 V battery or 8 -15 VDC</p>
Operating time:	Alcaline: without printer approx. 50 hours NiCd: without printer approx. 25 hours NiMh: without printer approx. 38 hours NC-TIMY: without printer approx. 25 hours NC-TIMY: with printer approx. 3000 lines
Charging:	depending on rechargeable battery, up to max. 18 hours
Printer:	graphic thermal printer, max. 6 lines per second
Temperature range:	TIMY S and P: -5 to 60°C TIMY XE and PXE: -20 to 60°C
Dimensions:	TIMY S and XE: 204 x 91 x 50 mm TIMY P and PXE: 307 x 91 x 65 mm
Weight:	TIMY S and XE: 450 g (without battery) TIMY P and PXE: 650 g (without battery and paper)

11.1 Pin assignment

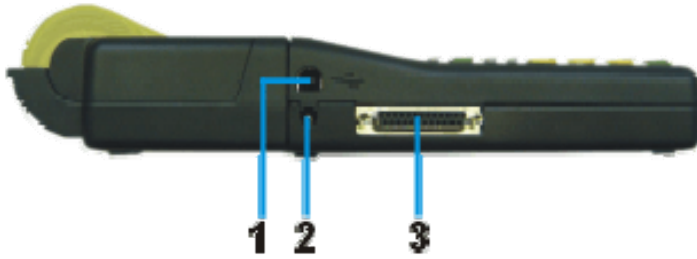

USB-Interface (1):

The USB-interface is used as interface between TIMY and PC. Via this interface the TIMY can completely be controlled and all data can be called.

Charger Connection (2):

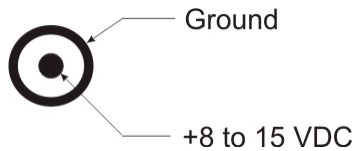

ALGE-Multiport (3):

Pin assignment:

- 1 terminal numbering connection
- 2 c0..... start channel (precision 1/10 000 s)
- 3 c2..... timing channel 2 (precision 1/10 000 s)
- 4 c3..... timing channel 3 (precision 1/10 000 s)
- 5 c7..... timing channel 7 (precision 1/100 s)
- 6 data output for display board
- 7 RS485B
- 8 RS485A
- 9 clock for terminals CLK
- 10 RS232 TX
- 11 RS232 RX
- 12 common ground GND
- 13 stabilized voltage out (+5V)
- 14 c1..... stop channel (precision 1/10 000 s)
- 15 c5..... timing channel 5 (precision 1/10 000 s)
- 16 c8..... timing channel 8 (precision 1/100 s)
- 17 c6..... timing channel 6 (precision 1/100 s)
- 18 c4..... timing channel 4 (precision 1/10 000 s)
- 19 RS232 RTS
- 20 printer data out
- 21 horn output 8 Ω
- 22 RS232 CTS
- 23 output voltage 7,5 - 14,5 VDC
- 24 common ground GND
- 25 power supply in or out (8 - 15 VDC)

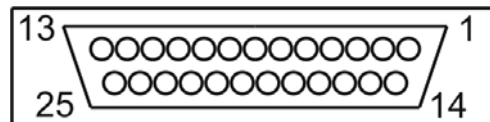

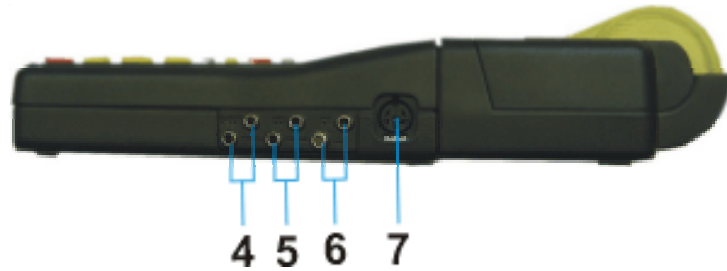

Banana plugs for displayboard (4)

Banana plugs for start channel C0 (5)

Banana plugs for stop channel C1 (6)



Photocell plug (7)

Pin assignment:

- 1 c0..... start channel
- 2 c1..... stop channel
- 3 GND... common ground
- 4 +Ua ... power supply 8-15 VDC
- 5 +5V ... stabilized voltage out (+5 VDC)
- 6 c2..... intermediate time channel

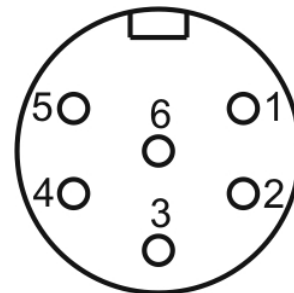

12 Interfaces

12.1 RS232 Interface

Output format: 1 start bit, 8 data bit, no parity bit, 1 stop bit
Bit rate: 9 600 baud factory setting
 adjustable: 2400, 4800, 9600, 19200, 28800, 38400
Transmission protocol: ASCII

yNNNNxCCCxHH:MM:SS.zhtqxGGRRRR(CR)

y first sign is blank or info (see below)
 x blank
 NNNN start number, max. 4-digit, prezeros are not shown
 CCC channels of timing device
 c0 channel 0 start channel
 c0M channel 0 triggered by keypad <START>
 c1 channel 1 finish channel
 c1M channel 1 triggered by keypad <STOP>
 c2 channel 2
 c3 channel 3
 c4 channel 4
 c5 channel 5
 c6 channel 6
 c7 channel 7
 c8 channel 8
 RT run time
 TT total time
 SQ sequential time (lap time)
 kmh speed measurement (possible displays: km/h, m/s, mph)
 HH:MM:SS.zhtq time in hours, minutes, seconds and 1/10 000 seconds
 GG group, lap or blank
 RRRR rank (only at classement available)
 (CR) carriage return

Info – the following figures may be in first position:

x blank
 ? time without valid start number
 m time from memory
 c times deleted (e.g. with CLEAR button)
 C memory time deleted (e.g. with CLEAR button)
 d times deleted due to disqualification
 i manually entered time with <INPUT>
 n enter new start number

Example of a RS 232 interface output (e.g. program backup)

```
0001 c0 15:43:49,8863 00      m 0008 c1 15:44:00,2849 00
0002 c0 15:43:50,1647 00      m 0009 c0 15:44:00,5499 00
0005 c1 15:43:51,6464 00      m 0010 c1 15:44:00,8182 00
0006 c0 15:43:51,9669 00      m 0011 c0 15:44:01,0366 00
0007 c1 15:43:52,2467 00      C 0011 c0 15:44:01,0366 00
0008 c0 15:43:52,4579 00      n 0014 c0 15:44:01,0366 00
0009 c1 15:43:52,6941 00      0020 c0 15:44:15,0077 00
0015 c0M 15:43:55,6200 00     0022 c0 15:44:15,5165 00
0016 c1M 15:43:55,8800 00     0023 c1 15:44:15,7847 00
0019 c0M 15:43:57,020 00      c 0023 c1 15:44:15,7847 00
m0007 c0 15:43:59.9927 00     i 0023 c1 15:44:15.7847 00
```

12.2 RS485 Interface

This function is not available at the moment.

12.3 Interface for displayboard

Output format: 1 start-bit, 8 data-bit, no parity-bit, 1 stop-bit

Bit rate: factory setting: 2.400 baud (neccessary for ALGE GAZ displayboard)
2400, 4800, 9600, 19200, 28800, 38400

Transmission protocol: ASCII

NNN.xxxxxxxxM:SSxxxx(CR)	Running time (without 1/10 seconds)
NNN.xxxxHH:MM:SSxxxx(CR)	Running time (without 1/10 seconds)
NNN.xxxxHH:MM:SS.zxx(CR)	Running time (with 1/10 seconds)
NNNCxxxxHH:MM:SS.zhtRR(CR)	Channel C1 finish time with rank
NNNCxxxxHH:MM:SS.zhtxx(CR)	Channel C1 finish time without rank
NNNDxxxxHH:MM:SS.zhtRR(CR)	Channel C1 total time with rank
NNNDxxxxHH:MM:SS.zhtxx(CR)	Channel C1 total time without rank
NNNAxxxxHH:MM:SS.zhtRR(CR)	Channel C2 1. intermediate time
NNNBxxxxHH:MM:SS.zhtRR(CR)	Channel C3 2. intermediate time
NNNExxxxHH:MM:SS.zhtRR(CR)	Channel C4 3. intermediate time
NNNFxxxxHH:MM:SS.zhtRR(CR)	Channel C5 4. intermediate time
NNNGxxxxHH:MM:SS.zhtRR(CR)	Channel C6 5. intermediate time
NNNHxxxxHH:MM:SS.zhtRR(CR)	Channel C7 6. intermediate time
NNNIxxxxHH:MM:SS.zhtRR(CR)	Channel C8 7. intermediate time
NNNSxxx©xxxxsxss.ssxRR(CR)	Speed

NNN	Start number (hundreds, tens, ones - digit 1 to 3); a point on the fourth digit is the identification for a running time
HH:MM:SS.zht	time in hours, minutes, seconds, and 1/1000 seconds
©	speed measurement: output of following ASCII signs: 01 hex for km/h, 02 hex for m/s, 03 hex for mph
RR	rank
x	blank
(CR)	carriage return

13 USB Interface

Currently available applications for USB interface:

- update the TIMY software with installation manager or TIMY USB program
- query and change of settings (as RS232)
- recording of times with program ComtoFile
- evaluation with program Time.NET
- evaluation with program Excel Writer

